

# FDC3300

## *Frequency Distribution Chassis*



## *User Manual*



---

# FDC3300

## *Frequency Distribution Chassis User Manual*

### **Preface**

Thank you for purchasing the Frequency Distribution Chassis. Our goal in developing this product is to bring you a distribution chassis that will quickly, easily and reliably meet or exceed your system requirements. Your new FDC3300 is fabricated using the highest quality materials and manufacturing processes available today, and will give you years of trouble-free service.

### **About EndRun Technologies**

EndRun Technologies is dedicated to the development and refinement of the technologies required to fulfill the demanding needs of the time and frequency community.

The instruments produced by EndRun Technologies have been selected as the timing reference for a variety of industries and applications - computer networks, satellite earth stations, power utilities, test ranges, broadcast and telecommunications systems and more.

EndRun Technologies is committed to fulfilling your precision timing needs by providing the most advanced, reliable and cost-effective time and frequency equipment available in the market today.

### **Trademark Acknowledgements**

IBM-PC, UNIX, Windows NT are registered trademarks of the respective holders.

Part No. USM3300-0000-000 Revision 9  
January 2018

Copyright © EndRun Technologies 2007-2018

---

## About This Manual

This manual will guide you through simple installation and set up procedures.

**Introduction** – The Frequency Distribution Chassis, how it works, where to use it, its main features.

**Basic Installation** – How to connect, configure and test your distribution chassis.

**Console Port** – Description of the console commands for use over the serial port or optional network port.

If you detect any inaccuracies or omissions, please inform us. EndRun Technologies cannot be held responsible for any technical or typographical errors and reserves the right to make changes to the product and manuals without prior notice.

## Warranty

This product, manufactured by EndRun Technologies, is warranted against defects in material and workmanship for a period of two years from date of shipment, under normal use and service. During the warranty period, EndRun Technologies will repair or replace products which prove to be defective.

For warranty service or repair, this product must be returned to EndRun Technologies. Buyer shall prepay shipping charges to send product to EndRun Technologies and EndRun Technologies shall pay shipping charges to return product to Buyer. However, if returned product proves to be operating normally (not defective) then Buyer shall pay for all shipping charges. If Buyer is located outside the U.S.A. then Buyer shall pay all duties and taxes, if any.

Products not manufactured by EndRun Technologies but included as an integral part of a system (e.g. peripherals, options) are warranted for ninety days, or longer as provided by the original equipment manufacturer, from date of shipment.

## Limitation of Warranty

The foregoing express warranty shall not apply to defects resulting from improper or inadequate maintenance by Buyer or User, Buyer-supplied software or interfacing, unauthorized modification or misuse, operation outside of the environmental specifications for the product, or improper site preparation or maintenance.

TO THE EXTENT PERMITTED BY LAW, THIS WARRANTY AND REMEDIES SET FORTH ABOVE ARE EXCLUSIVE AND IN LIEU OF ALL OTHER WARRANTIES, REMEDIES AND CONDITIONS WHETHER ORAL OR WRITTEN, STATUTORY, EXPRESS, OR IMPLIED. AS PERMITTED BY APPLICABLE LAW, ENDRUN SPECIFICALLY DISCLAIMS THE IMPLIED WARRANTIES OF MERCHANTABILITY OR FITNESS FOR A PARTICULAR PURPOSE.

---

## **Warranty Repair**

If you believe your equipment is in need of repair, call EndRun Technologies and ask for a customer service agent. It is important to contact us first as many problems may be resolved with a phone call. Please have the serial number of the unit and the nature of the problem available before you call. If it is determined that your equipment will require service, we will issue an RMA number. You will be asked for contact information, including your name, address, phone number and e-mail address.

Ship the unit prepaid in the original container or a container of sufficient strength and protection to EndRun Technologies. EndRun will not be responsible for damage incurred during shipping to us. Be sure the RMA number is clearly identified on the shipping container. Our policy is to fix or repair the unit within 5 business days. If it is necessary to order parts or if other circumstances arise that require more than 5 days, an EndRun service technician will contact you.

Loaner units are not included as part of the standard warranty.

## **Repair After Warranty Expiration**

If the warranty period has expired, we offer repair services for equipment you have purchased from EndRun. Call and ask for a customer service agent. It is important to contact us first as many problems may be resolved with a phone call. Please have the serial number of the unit and the nature of the problem available before you call. If it is determined that the equipment has failed and you want EndRun to perform the repairs, we will issue you an RMA number. Ship the unit prepaid in the original container or a container of sufficient strength and protection to EndRun Technologies. EndRun will not be responsible for damage incurred during shipping to us. Customer is responsible for shipping costs to and from EndRun Technologies. Be sure the RMA number is clearly identified on the shipping container. After the equipment has been received we will evaluate the nature of the problem and contact you with the cost to repair (parts and labor) and an estimate of the time necessary to complete the work.

## **Limitation of Liability**

The remedies provided herein are Buyer's sole and exclusive remedies. EndRun Technologies shall not be liable for any direct, indirect, special, incidental or consequential damages, whether based on contract, tort or any other legal theory.

## **EndRun Contact Information**

Address: EndRun Technologies  
2270 Northpoint Parkway  
Santa Rosa, California 95407  
U.S.A.  
Phone: (707)573-8633  
Fax: (707)573-8619  
Sales: 1-877-749-3878 or (707)573-8633  
sales@endruntechnologies.com  
Support: 1-877-749-3878 or (707)573-8633  
support@endruntechnologies.com



---

# Table of Contents

Preface .....	i
About EndRun Technologies .....	i
Trademark Acknowledgements .....	i
About This Manual .....	ii
Warranty .....	ii
Limitation of Warranty .....	ii
Warranty Repair .....	iii
Repair After Warranty Expiration .....	iii
Limitation of Liability .....	iii
EndRun Contact Information .....	iii
<b>Chapter One - Introduction .....</b>	<b>1</b>
Main Features .....	1
Overview .....	1
Performance, Reliability and Reasonable Cost .....	1
Flexibility .....	1
Easy Installation .....	1
Free FLASH Upgrades .....	2
Theory of Operation .....	2
Overview .....	2
<b>Chapter Two - Basic Installation .....</b>	<b>5</b>
Checking and Identifying the Hardware .....	5
FDC3300 Physical Description .....	6
Installing the FDC3300 .....	7
Mount the FDC3300 .....	7
Connecting the DC Power Option .....	7
Connect Serial I/O to Host Computer .....	8
Connect Signal Inputs and Outputs .....	8
Connect Disable Inputs (External Alarm Inputs) .....	8
Connect Alarm Output .....	8

---

<b>Chapter Three - Control and Status Commands</b> .....	9
Available User Commands .....	9
Detailed Command Descriptions .....	10
alarmlist .....	10
alarmstat .....	10
disablemode .....	11
disablestat .....	12
help .....	12
port .....	12
pwrstat .....	12
reset .....	13
respmode .....	13
return .....	13
selectedin .....	14
settings .....	14
siginstat .....	14
sigoutstat .....	14
status .....	14
switchmode .....	14
upload .....	15
ver .....	15
RS-232 Serial I/O Port Signal Definitions .....	16
<b>Appendix A - LED Indicators</b> .....	17
Power LEDs .....	17
Input LEDs .....	17
Output LEDs .....	18
Alarm LED .....	18
<b>Appendix B - Upgrading the Firmware</b> .....	19
What You Need To Perform the Upgrade .....	19
Performing the Upgrade .....	19
Problems with the Upgrade .....	20
Recover .....	20



---

<b>Appendix C - Network Port Option</b> .....	21
Overview .....	21
Available User Commands .....	22
Detailed Command Descriptions .....	22
netconfig .....	22
netmac .....	23
netpass .....	23
netprotocol .....	23
netreset .....	24
netsnmp .....	24
netsnmpro .....	24
netsnmprw .....	24
Upgrading Firmware .....	24
What You Need To Perform the Upgrade .....	25
Performing the Upgrade .....	25
Problems with the Upgrade .....	26
<b>Appendix D - Specifications</b> .....	27
<b>Special Modifications - Changes for Customer Requirements</b> .....	31



# Chapter One

## Introduction

*The FDC3300 Frequency Distribution Chassis is a 19" rack-mounted, dual-input, ten-output device for high-performance analog signal distribution with intelligent input fault detection and failover switching. In addition to reproducing the input signal with very low distortion and propagation delay, the unit features very good input-to-input, output-to-output and output-to-input isolation. It adds very low phase noise and spurious components to the distributed signal, making it suitable for demanding applications where high spectral purity is required. Status is locally observable on a cleanly designed front panel with LED indicators, and it is fully manageable via RS-232 or an optional ethernet port. Redundant AC, DC or AC/DC power inputs are optionally available.*

Visit <http://www.endruntechnologies.com/support.htm> to download firmware upgrades and get the latest manuals and other documentation.

## Main Features

### Overview

The FDC3300 may be employed either as a simple, single-input, ten-output signal distributor for non-critical applications, or, by making use of its intelligent dual-input failover switching and redundant power supply capabilities, high-availability signal distribution systems for top tier commercial and military applications may be efficiently implemented. The unit will accept a TTL or Open-Collector Alarm output signal from the upstream signal source on each of its two external alarm inputs so that bank switching of multiple FDC3300 units may be efficiently and synchronously implemented.

### Performance, Reliability and Reasonable Cost

It provides high performance and reliability combined with reasonable cost. Its internal sub-assemblies are fabricated with state-of-the-art components and processes and are integrated in a solid, high-quality chassis.

### Flexibility

It supports full user configuration of the input switching strategy and complete remote monitoring and control via multiple industry-standard interfaces.

### Easy Installation

Its standard 1U high, 19" rack-mountable chassis makes installation simple. It may be mounted in any convenient location. All signal input and output connectors are standard BNC female connectors. AC power input is via IEC-320 standard power cord. Connect it to your host computer using the standard RS-232 serial cable provided, or on ethernet equipped units, use the rear panel mounted 10/100Base-T RJ-45 connector and CAT-5 patch cable provided to connect it to your network. Initial network configuration is automatic on networks using the Dynamic Host Configuration Protocol (DHCP). Manual network configuration is via the RS-232 serial I/O port.

**Free FLASH Upgrades**

Firmware is stored in non-volatile FLASH memory, so the FDC3300 can be easily upgraded in the field using the local RS-232 port. We make all firmware upgrades for our products available to our customers free of charge.

**Theory of Operation****Overview**

The diagram below illustrates the FDC3300 architecture. Single or dual power supply operation is supported with any combination of AC or DC input voltages. (Installation of the second power supply is an option for the FDC3300.) The presence of proper voltage at the output of each of the two internal DC-DC converters is detected and monitored by the alarm logic and CPU. The outputs of these two power supplies are diode “OR’d” to power the FDC3300. When both power supplies are good, Power Supply A is active while Power Supply B remains on standby.

Single or dual signal inputs are detected and monitored by the alarm logic and CPU. In addition, single or dual TTL level disable inputs are monitored to allow switching based on the alarm output from the upstream signal source. This external alarm signal can be connected to rear-panel BNC connectors labeled “DISABLE IN”. These disable inputs are pulled up with 10k ohm resistors so that they may be connected to an open-collector output signal. Based on the status of the signal input level detection and the disable inputs, the alarm logic and CPU control the signal input switch. You can configure a variety of automatic switching strategies and also manually force the selection of either input.

The output signal from the switch is buffered and drives ten broadband output amplifiers. Output signal level detectors for each of the ten channels are monitored by the alarm logic and CPU so that output amplifier failure or interconnect cable short circuits may be observed.

All status information is reported via the front-panel LEDs and the serial I/O port or optional ethernet interface. A summary open-collector alarm output is provided.

## Functional Block Diagram

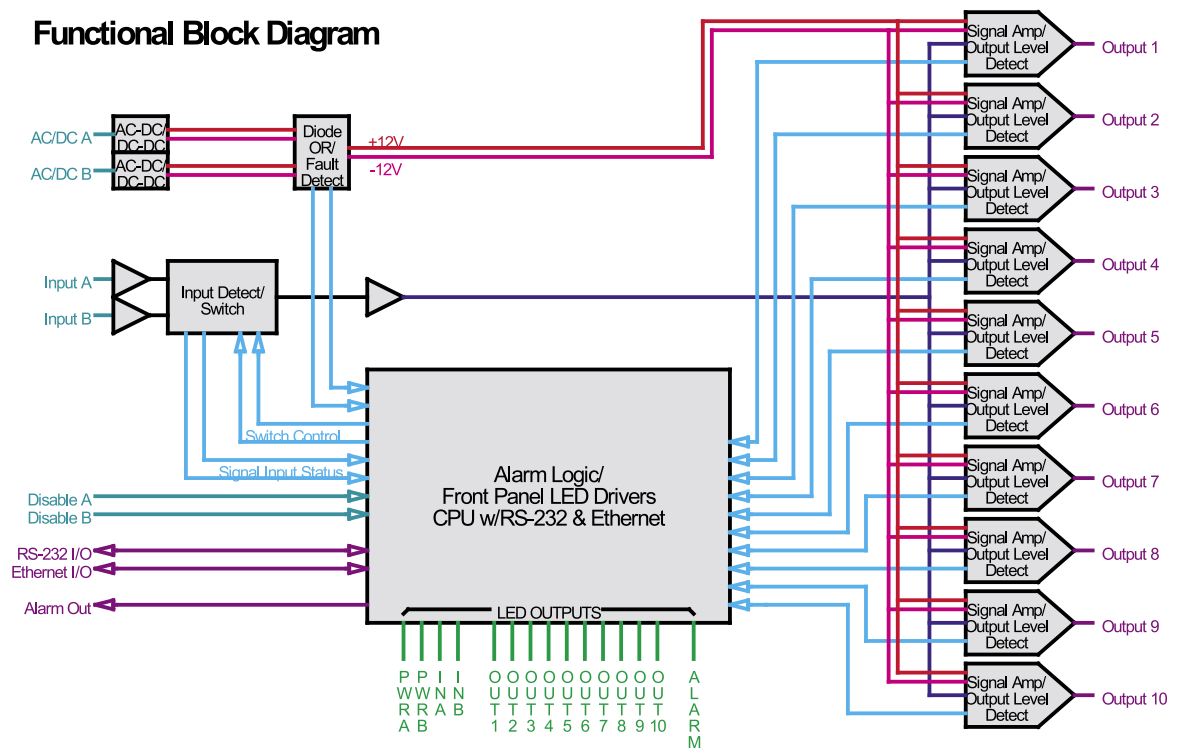



# Chapter Two

## *Basic Installation*

---

*This chapter will guide you through the most basic checkout and physical installation of your FDC3300 Frequency Distribution Chassis. Subsequent chapters and appendices will give you the information needed to configure your installation for the maximum performance in your operating environment.*

### **Checking and Identifying the Hardware**

Unpack and check all the items using the shipment packing list. Contact the factory if anything is missing or damaged. The FDC3300 shipment typically contains:

- FDC3300 (part # 3300-0001-000 or #3300- variant)
- FDC3300 User Manual (part #USM3300-0000-000)
- IEC 320 AC Power Cord (part #0501-0003-000)  
(This part will not be present if using the DC power option.)
- DB9F-to-DB9F Null Modem Serial I/O Cable (part #0501-0002-000)
- RJ-45 to RJ-45 CAT-5 patch cable, 2 meters (part #0501-0000-000)  
(This part present only with units configured with the Ethernet Interface option.)

## FDC3300 Physical Description

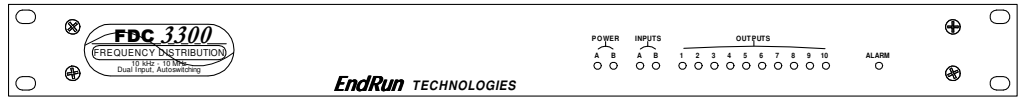

- Power A/B LEDs**                      These red/green LEDs indicate power input status. Green means the power supply is good. Red means the power supply is installed but has failed. Off means the optional power supply is not installed. Power B is on standby when both supplies are good.
- Input A/B LEDs**                      These red/green/yellow LEDs indicate the signal input status. For a full description see *Appendix A - LED Indicators*.
- Output 1-10 LEDs**                    These red/green/yellow LEDs indicate the presence or absence of signals at the output connectors. Green means the output is present and red means the output is absent or shorted.
- Alarm LED**                              This red/green/yellow LED indicates the presence of a fault condition. Green means there is no alarm condition. Red means an alarm condition exists. Use the `alarmstat` or `alarmlist` commands for more information (see *Chapter 3 - Control and Status Commands*).

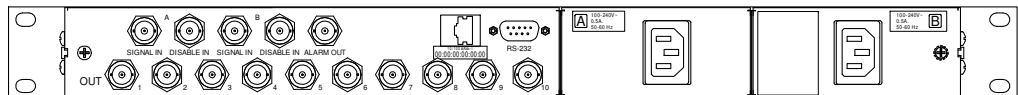

- RS-232 Connector**                    This DB-9M connector provides the RS-232 serial I/O interface to the FDC3300. This allows the user to initialize, monitor and control the FDC3300. See *Chapter 3 - RS-232 Serial I/O Port Signal Definitions* for detailed information.
- 10/100Base-T Jack**                    This optional RJ-45 connector mates with the ethernet twisted pair cable from the network.
- Signal Input A/B Jacks**                These two BNC connectors accept the A and B analog signal inputs.
- Disable Input A/B Jacks**                These two BNC connectors accept the A and B logic level external alarm inputs. If properly configured (see `disablemode`), a high level on this input will disable the corresponding Signal Input.
- Alarm Output Jack**                      This BNC connector provides the open-collector Alarm output. This output is asserted during the power-on/startup sequence and when an alarm condition exists.



---

## BASIC INSTALLATION

Signal Output 1-10 Jacks	These ten BNC connectors provide the analog signal outputs.
AC Power Input Jack	This IEC 320 standard three-prong connector provides AC power.
DC Power Input Block	This optional 3-position terminal block provides connection to the DC power source, and replaces the AC power input jack. See details in <i>Appendix D - Specifications</i> .

### Installing the FDC3300

#### FCC NOTICE

This equipment has been tested and found to comply with the limits for a Class A digital device, pursuant to part 15 of the FCC Rules. These limits are designed to provide reasonable protection against harmful interference when the equipment is operated in a commercial environment. This equipment generates, uses, and can radiate radio frequency energy and, if not installed and used in accordance with the instruction manual, may cause harmful interference to radio communications. Operation of this equipment in a residential area is likely to cause harmful interference in which case the user will be required to correct the interference at his own expense.

#### Mount the FDC3300

Using standard 19" rack mounting hardware, mount the unit in the desired location.

#### CAUTION

Ground the unit properly with the supplied power cord.

The socket outlet should be installed near the equipment and be easily accessible.

Power cord is used as a disconnection device. To de-energize equipment, disconnect the power cord. If your FDC3300 has dual power supplies, then multiple power cords may be installed. To de-energize this equipment, disconnect all power cords from the device.

Do not install the FDC3300 where the operating ambient temperature might exceed 122°F (50°C).

#### Connecting the DC Power Option

Connect the safety ground terminal to earth ground. Connect the "+" terminal to the positive output of the DC power source. Connect the "-" terminal to the negative output of the DC power source. Note that the FDC3300 has a "floating" internal power supply, therefore either the positive or negative output of the DC power source can be referenced to earth ground. This unit will not operate if the +/- connections are reversed; however it will not be damaged by a reverse connection.

**SHOCK/ENERGY HAZARD**

Install in Restricted Access Location.

Use 10-14 AWG copper wire only.

Terminal block screw torque: 9 in-lbs (1 nM).

Branch circuit must have circuit breaker, 15A or less.

Power must be sourced via two-pole disconnect device.

Install terminal block cover after wiring.

**Connect Serial I/O to Host Computer**

Using the standard null-modem DB9F-to-DB9F cable provided, connect one end to the FDC3300 connector labeled RS-232 and the other end to an available DB9M RS-232 connector on your host computer. The factory default serial port parameters are 19200 baud, 8 data bits, no parity and 1 stop bit. The FDC3300 does not use hardware or software handshaking, so make sure that your terminal program is configured appropriately and disable all handshaking.

**Connect Signal Inputs and Outputs**

Using coaxial cables, connect your analog signal(s) to the Signal Input A and/or Signal Input B on the FDC3300. The factory default for the FDC3300 **switchmode** setting is for Signal Input A to be the primary and Signal Input B to be the secondary. You can change this by using the **switchmode** command over the serial I/O port.

Connect coaxial cables from each of the FDC3300 signal outputs to your equipment.

**Connect Disable Inputs (External Alarm Inputs)**

If the source(s) of your reference signal(s) has (have) compatible TTL alarm output(s) that you would like to use to force signal input switching on your FDC3300, connect these using coaxial cables to the Disable A and/or Disable B input(s) on the FDC3300. The factory default for the FDC3300 **disablemode** setting is to ignore these inputs. If you plan to use them, you will need to use the **disablemode** command over the serial I/O port to configure them.

**Connect Alarm Output**

If you are using the FDC3300 summary alarm output, connect a coaxial cable from the equipment that will be monitoring the FDC3300 to the Alarm output on the FDC3300.

# Chapter Three

## Control and Status Commands

*This chapter describes the FDC3300 control and status commands. The FDC3300 supports commands for performing initialization/setup and for monitoring the performance and status of the unit. The serial I/O port physical and electrical characteristics are defined as well.*

### Available User Commands

COMMAND	FUNCTION
alarmlist	Prints a list of all current system alarms and OK if no alarms.
alarmstat	Prints system alarm information as a series of zeros and ones. Where '1' means the alarm is asserted and '0' means it is not. An 'x' means it is not installed.
disablemode	Configures Disable A and Disable B inputs.
disablestat	Prints the current status of the Disable A and Disable B inputs. A '1' means the input is asserted and '0' means it is not.
help	Prints help for all distribution chassis commands.
port	Configures serial port baud rate, data bits, parity and stop bits.
pwrstat	Prints the current status of the power supplies. A '1' means the power supply is operational. A '0' means it is not.
reset	This command will cause a system reset.
respmode	Configures the way the serial port responds to commands, either TERSE or VERBOSE.
return	Tells the distribution chassis to return to the primary input.
selectedin	Prints the currently selected Signal Input A, B or NONE.
settings	Prints all user setting commands which include DISABLE-MODE, PORT, RESPMODE and SWITCHMODE.
signinstat	Prints the current status of Signal Inputs A and B. A '1' means the signal is present and a '0' means it is not.
sigoutstat	Prints the current status of the Signal Outputs 1 through 10 as a sequence of 10 characters. A '1' means the signal is present and a '0' means it is not.
status	Prints all system status commands which include ALARM-LIST, ALARMSTAT, DISABLESTAT, PWRSTAT, SELECT-EDIN, SIGINSTAT, and SIGOUTSTAT.
switchmode	Configures the switching mode, AB, BA, A or B.
upload	Starts a software upload process.
ver	Prints the software and FPGA version information.

All entered commands are assumed to be terminated with a carriage return. Line feeds are ignored. All responses from the FDC3300 are terminated with a carriage return and a line feed.

## Detailed Command Descriptions

### alarmlist

This query-only command displays the current system alarms as a list of descriptive messages. The following is an example:

```
Query:          alarmlist
Chassis response:  Input B signal absent
                  Disable B asserted
```

### alarmstat

This query-only command displays the current system alarms as a series of characters, listed left to right. Each character is a '0', a '1' or an 'x'. A '1' means the corresponding alarm is active. A '0' means it is OK. An 'x' means the optional component is not installed in this particular unit.

Group 1 (6 characters)	Group 2 (10 characters)	Group 3 (4 characters)
Signal Input A absent	Output 1 signal absent	System Oscillator error
Signal Input B absent	Output 2 signal absent	Flash error
Disable A asserted	Output 3 signal absent	FPGA error
Disable B asserted	Output 4 signal absent	Network port error (option)
Power Supply A failed	Output 5 signal absent	
Power Supply B failed (option)	Output 6 signal absent	
	Output 7 signal absent	
	Output 8 signal absent	
	Output 9 signal absent	
	Output 10 signal absent	

```
Query:          alarmstat
Chassis response: 01000x 0000000000 000x
```

(An alarm exists on Signal Input B. Also, Power Supply B and the Network Port are not installed.)

**NOTE**

System alarms will clear automatically once the problem has been corrected.

**disablemode**

This command allows you to select external alarm inputs from the reference source (if any) as specified in Appendix D. (These inputs are labeled “DISABLE IN” on the rear-panel.) When the external alarm input is asserted it will disable the corresponding reference signal input and/or set a system alarm. If you are not using external alarms then set `disablemode=n,n`.

The `disablemode` syntax is `disablemode=a,b,x` where Parameter **a** may be Y (yes) or N (no) for whether to use the Disable A input or not. Parameter **b** may be Y or N for whether to use the Disable B input or not. (Depending upon the `switchmode` setting, either the **a** or **b** setting could be a “don’t care” and would be ignored. For example, if `switchmode=a`, then Parameter **b** in the `disablemode` command would be ignored.) Parameter **x** tells the chassis what action to take when there is no good input signal to switch to. **x**=ON to leave the last selected input switched on, or **x**=OFF to switch the last selected input off. This parameter can be left blank if both disable inputs are to be ignored.

If `disablemode=n,n` the chassis will ignore the Disable A and Disable B inputs.

If `disablemode=y,y,off` (or `n,y,off` or `y,n,off`) the chassis will turn off the reference input when it sees the disable input asserted and there is no good signal present on the other signal input. For example:

Example 1: If `disablemode=y,n,off` and `switchmode=a` then there is no secondary reference input and the chassis cannot switch if the Disable A input is asserted. If Disable A is asserted, Signal Input A will be switched off, which will turn off all the outputs.

Example 2: If `disablemode=y,y,off` and `switchmode=ab` and the Disable A input is asserted, the chassis will attempt to switch to Signal Input B. However, if Signal Input B has a fault condition (input signal goes away or Disable B is asserted) then Signal Input A will be switched off, which will turn off all the outputs.

Once both inputs have been switched off then you must use the `return` command to restore the unit to a normal operating condition.

If `disablemode=y,y,on` (or `n,y,on` or `y,n,on`) then the chassis will switch between the primary and secondary inputs as described above when the disable input is asserted. In this example the chassis will not switch the signal input off as described above, but will leave the signal input switched on. This will leave all the outputs on.

Typing `disablemode` by itself, with no parameters, will display the current setting.

If you change this setting it will be saved in non-volatile memory. *This is a configuration command and if the parameters are changed this will cause a re-initialization of the software.*

Set:	<code>disablemode=y,n,on</code>
Chassis response:	<b>OK</b> (Disable A is valid and Disable B is ignored. The chassis will leave the inputs on if Disable A is asserted.)

Query: **disablemode**  
Chassis response: **y,n,on**  
  
Factory default setting: **n,n**

**disablestat**

This query-only command shows the status (signal levels) of the Disable A and Disable B inputs. The first character is for Disable A and the second character is for Disable B. A '0' means the disable input is low, and a '1' means the disable input is high (asserted - a fault condition).

Query: **disablestat**  
Chassis response: **01** (Disable B input is asserted. Disable A is not.)

**help**

This query-only command displays a list of the distribution chassis commands. To get help on a particular command you would type **help**, followed by the command..

Query: **help**  
Chassis response: All commands are displayed.  
Query: **help port**  
Chassis response: Information specific to the **port** command is displayed.

**port**

This command sets the serial port parameters of baud rate, data bits, parity and stop bits. If you change these parameters they will be saved in non-volatile memory. Syntax is: port=b,d,p,s. Where:

b is baud rate: 9600, 19200, 38400 or 57600.  
d is data bits: 7 or 8.  
p is parity: o, e or n (for odd, even or none)  
s is stop bits: 1 or 2

Set: **port=57600,8,n,1**  
Chassis response: **OK** (The serial port is reset with the new parameters)

Query: **port**  
Chassis response: **57600,8,n,1**

Factory default setting: **19200,8,n,1.**

**pwrstat**

This query-only command shows the status of the power supplies and power inputs. The distribution chassis is capable of having two power supplies (for redundancy) but the standard unit has only one. The second is an option. The **pwrstat** response will show two characters - the first is for the standard power supply. The second is for the optional power supply. A '0' means the power input is not present, the power supply has failed, or the power supply is not installed (in the case of the optional

supply). A one '1' means the power supply is good. An 'x' means the optional power supply is not installed.

Query: **pwrstat**  
Chassis response: **1x** (The first supply (Power A) is good. The second supply (Power B) is not installed.)

**reset**

This command will cause a software reset.

Command: **reset**  
Chassis response: **OK** (The chassis will reset.)

**respmode**

This command configures the way the chassis responds to commands. If you change this setting it will be saved in non-volatile memory. Command syntax is: **respmode = x**, where x is either TERSE or VERBOSE. The TERSE mode means that when a command is entered the chassis will respond with only data. The VERBOSE mode means that when a command is entered the chassis will respond with the command name and equal sign followed by the data (for example: **ratea=1000**).

Set: **respmode=verbose**  
Chassis response: **OK** (The chassis will respond to all future commands and queries by including the command name.)

Query: **respmode**  
Chassis response: **terse**  
or  
Query: **respmode**  
Chassis response: **respmode=verbose**

Factory default setting: **terse**

**return**

After the chassis has switched from the primary to the secondary signal input, this command is used to return to the primary input. After you have restored the signal on primary input, type **return** to force the chassis to switch back to primary. An alternate way to force the chassis to switch back to the primary input is by removing the secondary disable input (provided that **disablemode** has been configured properly). It is also possible to accomplish the return by physically disconnecting the secondary input momentarily. However this will cause a brief interruption in the output signal during the switch. For this reason, using **return** or the disable input are the preferred methods.

This command is also used after the chassis has switched from the primary signal input to no signal input (**selectedin=NONE**). This will occur if **disablemode** has been configured to allow it. If the selected input is NONE then correct the problem and enter the **return** command to restore the unit to proper operation.

Command: **return**  
Chassis response: **OK** (The chassis will return to the primary input.)

**selectedin**

This query-only command shows the currently selected signal input, either A, B or NONE.

```
Query:                selectedin
Chassis response:    A      (Currently selected input is Signal Input A.)
```

**settings**

This query command displays all user command settings.

```
Query:                settings
Chassis response:    disablemode = Y,Y,ON
                    port = 57600,8,N,1
                    respmode = VERBOSE
                    switchmode = AB
```

**siginstat**

This query-only command shows the current status of both Signal Inputs A and B. The first character is for Signal Input A and the second character is for Signal Input B. A '0' means a signal is not present and a '1' means a signal is present.

```
Query:                siginstat
Chassis response:    10      (Signal Input A is present. Signal Input B is not.)
```

**sigoutstat**

This query-only command shows the current status of Output Signals 1 through 10. The first character is for Output 1, the second is for Output 2, and so on. A '0' means there is no input signal, the output driver is bad or a short is connected to it. A one '1' means there is an input signal and the output signal is good.

```
Query:                sigoutstat
Chassis response:    1011111111 (A problem exists at Output 2.)
```

**status**

This command displays the results of all status query commands.

```
Query:                status
Chassis response:    alarm = 00000x 0000000000 000x
                    disablestat = 00
                    pwrstat = 10
                    selectedin = A
                    siginstat = 11
                    sigoutstat = 1111111111
```

**switchmode**

This command sets the switching mode in case a fault is detected. A fault is either lack of signal presence or a logic high level on Disable A or Disable B, provided these have been configured properly (see **disablemode**). Syntax is: **switchmode=x**, where **x** is A, B, AB, or BA. If **switchmode=ab** then the chassis will use Signal Input A as its primary source and Signal Input B



as its secondary source. This means the chassis will switch to Signal Input B if a problem on A occurs. If **switchmode=ba** then the reverse is true. If **switchmode=a** or **switchmode=b** then there is no secondary input. The chassis will either remain on the primary signal input or will switch it off, depending on the **disablemode** setting. Typing **switchmode** with no parameter will display the current **switchmode** setting.

If you change this setting it will be saved in non-volatile memory. *This is a configuration command and if the parameters are changed this will cause a re-initialization of the software.*

Set:	<b>switchmode=ba</b>
Chassis response:	<b>OK</b> (B is primary. A secondary.)
Query:	<b>switchmode</b>
Chassis response:	<b>ba</b>
Factory default setting:	<b>ab</b>

### **upload**

This command allows you to upgrade the distribution chassis software. See *Appendix B - Upgrading the Firmware* for more information.

Command:	<b>upload</b>
Chassis response:	<b>OK</b> (The chassis will begin the upload process.)

### **ver**

This query-only command will show the current firmware and FPGA version information.

Command:	<b>ver</b>
Chassis response:	<b>FW 6010-0061-000 1.00 - Oct 19 2007 10:04:47 FPGA 6020-000x-000 v 86K</b>

**RS-232 Serial I/O Port  
Signal Definitions**

The RS-232 DB9M connector on the rear panel of the distribution chassis is wired as shown below. In order to connect the distribution chassis to another computer, a null-modem adapter must be used. The serial cable provided with the shipment is wired as a null-modem adapter and can be used to connect the distribution chassis to your computer.

<b>FDC3300 DB9M Pin</b>	<b>Signal Name</b>
1	Not Connected
2	Receive Data (RX)
3	Transmit Data (TX)
4	Not Connected
5	Ground
6	Not Connected
7	Not Connected
8	Not Connected
9	Not Connected

# Appendix A

## LED Indicators

This chapter describes the distribution chassis LED indicators and what they mean.

### Power LEDs

COLOR	MEANING
Green	Power supply is good.
Red	One of the power supplies has failed. This condition will only exist in a unit with redundant power supplies.
Off	The redundant power supply is not installed.

### Input LEDs

The operation of these LEDs depends on the **switchmode** and **disablemode** settings (see *Chapter 3 - Control and Status Commands*). The switchmode command determines whether a particular Signal Input should be present or not. For example, if switchmode=a then Signal Input B need not be present.

COLOR	MEANING
Green	The signal input is selected as the current input.
Red	The signal input should be present but it is not. See <b>switchmode</b> to determine whether a signal input should be present or not.
Flashing Red	The signal input should be present but its corresponding disable input has been enabled (see <b>disablemode</b> ) and is asserted.
Yellow	The signal input is present but is not selected as the current input.
Flashing Yellow	The signal input is present, but should not be (see <b>switchmode</b> ) and its corresponding disable input has been enabled (see <b>disablemode</b> ) and is asserted. This usually occurs only when the user has configured the system incorrectly. For example, a secondary input has been connected and its disable input has been enabled but <b>switchmode</b> is configured as <b>switchmode=a</b> or <b>switchmode=b</b> .
Off	The signal input is not present and should not be present per <b>switchmode</b> .

**Output LEDs**

<b>COLOR</b>	<b>MEANING</b>
Green	The output is present.
Red	The output is absent, shorted, or the output driver has failed.

**Alarm LED**

<b>COLOR</b>	<b>MEANING</b>
Green	No alarm condition exists.
Red	An alarm condition exists. See commands <b>alarmlist</b> and <b>alarmstat</b> for more information.

# Appendix B

## Upgrading the Firmware

Periodically, EndRun Technologies will make bug fixes and enhancements to our products available for download from our website. All such downloads are freely available to our customers, without charge. After you have downloaded the appropriate FLASH binary image file from the EndRun Technologies website, you are ready to perform the upgrade to your distribution chassis.

This appendix contains instructions for upgrading via the RS-232 serial port. See **Appendix C - Network Port Option** for instructions on upgrading via the network port.

### What You Need To Perform the Upgrade

You will need a terminal program which supports file uploading using protocols XMODEM 128 with CRC or XMODEM 1K with CRC. These are very common file transfer protocols and should be supported by virtually any terminal program.

#### CAUTION

You may perform the upload using any of the supported serial I/O parameter combinations, *except that 8 data bits must be used*. You must use 8 data bits because the FLASH image that you will be uploading is in a binary format.

### Performing the Upgrade

Configure your terminal program and the distribution chassis to communicate at the desired baud rate by using the settings facility for your terminal program and the `port` command for the distribution chassis. Refer to **Section 3 - Control and Status Commands** for details on using the `port` command.

#### CAUTION

Make sure only one port (serial or network) is active during the upgrade procedure. In other words, if using the serial port to upgrade, make sure there is no activity on the network port (if any).

After establishing communications with the distribution chassis using the desired port settings, issue the following command to initiate the upload:

```
upload<CR><LF>
```

After issuing this command, you will see the distribution chassis respond with this message:

```
Waiting for download using XMODEM 128 or XMODEM 1K (both with CRC).  
Control X will abort download.  
CCC...
```

You will then see the distribution chassis send the character ‘C’ every three seconds while it is waiting for you to begin uploading the image file. Should you need to abort the upload process now, send CTRL-X to the distribution chassis. If you abort at this time, your current firmware will remain intact. If you abort after the file transfer is in progress, you will not retain your original firmware and will need to re-upload it.

Otherwise, start the upload using the appropriate method for your terminal program. During the upload, your terminal program will display some sort of status indication. If the upload is successful, you will see the distribution chassis reboot, displaying the firmware version information when it does. Note the firmware version information at this time and verify that it is indeed the firmware that you intended to upload to the distribution chassis. If it is, you have successfully upgraded the firmware.

## **Problems with the Upgrade**

Should you have difficulties with the upgrade due to a corrupt file, power failure during upload, or other accident, do not be alarmed. Even though you may have lost the existing application program, the distribution chassis bootloader program will remain intact. On boot up, it will check to see if a valid application program is in the FLASH memory. If there is not, it will immediately go into the ‘waiting for download’ mode, sending the ‘C’ character every three seconds. You may then retry the upload procedure, after you have corrected the original problem.

It is possible for the bootloader program to be fooled by a corrupted application program that has been previously downloaded into FLASH. In this case, it will attempt to start the application program. Generally this will result in a failure that will force a watchdog initiated reboot. This process will be repeated indefinitely unless you intervene.

### **Recover**

If the bootload/application launch sequence appears to be caught in a loop, type “recover” right after the bootloader version string is displayed. This will cause the bootloader to ignore the presence of what it thinks is a valid application program in FLASH and force the bootloader to initiate the XMODEM upload sequence. When you see the character ‘C’ being displayed every three seconds, you may initiate the upload of a new application program file.

# Appendix C

## Network Port Option

*This option allows you to monitor and control your FDC3300 via TCP/IP. Specifically, the **telnet**, **ssh** and **snmp** protocols are supported. The **snmp** support is MIB II compliant, however no enterprise MIB is implemented. Either **telnet** or **ssh** may be used to control and monitor the instrument state, but both protocols cannot be active at the same time. The Dynamic Host Configuration Protocol (**DHCP**) is enabled by default for automatically setting the FDC3300 IP address parameters, but you may also statically set these using the **netconfig** command.*

### Overview

By default your FDC3300 will accept connections on the standard **telnet** port 23. After entering the password, use the **help** command to get started. To get help on a particular command, type help followed by the command. For example:

Query:	<b>help</b>
Chassis response:	All commands are displayed.
Query:	<b>help port</b>
Chassis response:	Information specific to the <b>port</b> command is displayed.

You may optionally configure the unit to accept connections on the standard **ssh** port 22. (Use the **netprotocol** command.) When logging in via **ssh**, be prepared to wait for about 30 seconds for the password entry prompt to appear on your terminal. A public/private RSA key pair of length 1024 and a DSA key pair of length 512 have been created at the factory for use with **ssh**. After entering the password, type “help” and press enter to see the command list and descriptions.

#### TELNET NOTE

Factory default password:	endrun_1
---------------------------	----------

#### SSH NOTE

User name:	root
Factory default password:	endrun_1

## Available User Commands

In addition to the commands described in *Chapter 3 - Control and Status Commands*, when your FDC3300 is configured with the Network Port Option, these commands are also available.

COMMAND	FUNCTION
netconfig	Configures the IP network addressing parameters.
netmac	Shows the Media Access Control (MAC), or ethernet, address of the network port.
netpass	Sets the password for accessing the network port via Telnet or SSH. Default password is endrun_1.
netprotocol	Sets the protocol for accessing the network port - either Telnet or SSH.
netreset	Resets the network port.
netsnmp	Turns SNMP on or off.
netsnmpro	Sets the SNMP read-only community string. Default read-only community string is fdc_user.
netsnmprw	Sets the SNMP read-write community string. Default read-write community string is endrun_1.

All entered commands are assumed to be terminated with a carriage return. Line feeds are ignored. All responses from the FDC3300 are terminated with a carriage return and a line feed.

## Detailed Command Descriptions

### netconfig

This command queries or sets the IP network addressing parameters that are stored in FLASH. After setting new addresses, enter the **netreset** command for these settings to take effect on the network port. Command syntax is:

**netconfig=d,i,n,g,p,s**

d is ON or OFF to enable or disable DHCP.

If DHCP is ON, then enter the command as: **netconfig=ON**. No other fields are necessary.

If DHCP is OFF, then enter these remaining fields:

i is the IP Address 111.222.333.444

n is the Netmask 111.222.333.444

g is the Gateway Address 111.222.333.444 or hyphen '-' if you are not using one.

p is the primary DNS Address 111.222.333.444 or hyphen '-' if you are not using one.

s is the secondary DNS Address 111.222.333.444 or hyphen '-' if you are not using one.

In the example below the user is disabling DHCP and setting the IP address, netmask, gateway and the primary DNS address. The secondary DNS is not used.



---

## NETWORK PORT OPTION

Set:

```
netconfig = OFF,192.168.1.135,255.255.255.0,192.168.1.1,192.168.1.1,-
```

```
Chassis response:      OK  
                       Reset network port ("netreset") for these settings  
                       to take effect.
```

Query: **netconfig**

Chassis response:

```
netconfig = OFF,192.168.1.135,255.255.255.0,192.168.1.1,192.168.1.1,0.0.0.0
```

Factory default setting: **netconfig = ON**

### NOTE

If using DHCP, in addition to the IP address and netmask, ensure that the DHCP server also assigns a gateway, or Telnet and SSH may not connect.

### netmac

This is a query-only command shows the Media Access Control (MAC) address of the ethernet network port.

Query: **netmac**

```
Chassis response:      netmac = 0:20:4a:94:32:ae
```

### netpass

This command sets the password for accessing the network port via Telnet or SSH. The password must be at least 8 and less than 32 characters. Characters must be alphanumeric or the underscore '\_'. Entering control-C will quit without changing the password. There is no query mode for this command.

Set: **netpass**

```
Chassis response:      System prompts user for the password.
```

Factory default password: **endrun\_1**

### netprotocol

This command sets or queries for the protocol used for accessing the network port. Choices are either Telnet or SSH. Syntax is: netprotocol=x, where x is either Telnet or SSH.

Set: **netprotocol=ssh**

```
Chassis response:      OK
```

Query: **netprotocol**

```
Chassis response:      ssh
```

Factory default setting: **telnet**

**netreset**

This command will reset the network port. This is needed after the network parameters are changed. For example, if you change from DHCP on to off then you will need to reset the network port.

Command: **netreset**  
Chassis response: **Resetting network port.....**

**netsnmp**

This command enables or disables SNMP. Syntax is: `netsnmp = x` where x is on or off.

Set: **netsnmp=on**  
Chassis response: **OK**

Query: **netsnmp**  
Chassis response: **on**

Factory default setting: **off**

**netsnmpro**

This command sets the SNMP read-only community string. The community string must be at least 8 and less than 32 characters. Characters must be alphanumeric or the underscore ‘\_’. Entering control-C will quit without changing the community string. There is no query mode for this command.

Set: **netsnmpro**  
Chassis response: System prompts for the SNMP read-only community string.

Factory default password: **fdc\_user**

**netsnmprw**

This command sets the SNMP read-write community string. The community string must be at least 8 and less than 32 characters. Characters must be alphanumeric or the underscore ‘\_’. Entering control-C will quit without changing the community string. There is no query-mode for this command.

Set: **netsnmprw**  
Chassis response: System prompts for the SNMP read-write community string.

Factory default password: **endrun\_1**

## Upgrading Firmware

Periodically, EndRun Technologies will make bug fixes and enhancements to our products available for download from our website. All such downloads are freely available to our customers, without charge. After you have downloaded the appropriate FLASH binary image file from the EndRun Technologies website, you are ready to perform the upgrade to your distribution chassis.

For instructions on upgrading firmware using the serial port see *Appendix B - Upgrading the Firmware*. This section contains instructions for upgrading firmware via the network port. Upgrading firmware via the TCP/IP network interface is supported using Telnet only. Upgrading via SSH is not supported.

**CAUTION**

**Make sure only one port (serial or network) is active during the upgrade procedure. In other words, if using the network port to upgrade, make sure there is no activity on the serial port.**

**What You Need To Perform the Upgrade**

You will need a terminal program which can connect to your FDC3300 via Telnet and supports file uploading using protocols XMODEM 128 with CRC or XMODEM 1K with CRC. These are very common file transfer protocols and should be supported by virtually any terminal program. Less common is a terminal program capable of connecting using Telnet. A recommended program for the Windows platform is ZOC, available from Emtec: <http://www.emtec.com>.

**Performing the Upgrade**

Configure your terminal program to perform XMODEM file transfers with CRC, using either 128 byte blocks or 1K (1024) byte blocks. Then issue this command:

```
upload<CR><LF>
```

After issuing this command, you will see the distribution chassis respond with this message:

```
Waiting for download using XMODEM 128 or XMODEM 1K (both with CRC).  
Control X will abort download.  
CCC...
```

You will then see the distribution chassis send the character 'C' every three seconds while it is waiting for you to begin uploading the image file. Should you need to abort the upload process now, send CTRL-X to the distribution chassis. If you abort at this time, your current firmware will remain intact. If you abort after the file transfer is in progress, you will not retain your original firmware and will need to re-upload it. You will have to use the RS-232 port to do that.

Otherwise, start the XMODEM upload using the appropriate method for your terminal program. During the upload, your terminal program will display some sort of status indication. If the upload is successful, you will see the distribution chassis reboot, displaying this message just prior to doing so:

```
Download Complete. Network connection closing.  
Allow 90 seconds before re-connecting.
```

After re-connecting via Telnet, issue the **ver** command and verify that it is indeed the firmware that you intended to upload to the distribution chassis. If it is, you have successfully upgraded the firmware.

**Problems with the Upgrade**

In general, if you fail to upgrade the firmware successfully, you will need to use the RS-232 port to recover. Should you have difficulties with the upload due to a corrupt file, power failure during upload, or other accident, do not be alarmed. Even though you may have lost the existing application program, the distribution chassis bootloader program will remain intact. On boot up, it will check to see if a valid application program is in the FLASH memory. If there is not, it will immediately go into the 'waiting for download' mode, sending the 'C' character every three seconds. You may then retry the upload procedure, after you have corrected the original problem.

It is possible for the bootloader program to be fooled by a corrupted application program that has been previously downloaded into FLASH. In this case, it will attempt to start the application program. Generally this will result in a failure that will force a watchdog initiated reboot. This process will be repeated indefinitely unless you intervene.

If the bootload/application launch sequence appears to be caught in a loop, then you will need to use the serial port to correct the problem. Please see *Appendix B - Upgrading the Firmware, Recover*.

# Appendix D

## *Specifications*

### **Reference Inputs (A or B):**

Frequency Range: 10 kHz to 10 MHz.

Impedance: 50Ω, SWR < 1.1.

Amplitude: +13 dBm Full Performance, +3 dBm minimum, +19 dBm maximum.

A Input to B Input Isolation: < -90 dB, full frequency range.

Output to Input (Reverse) Isolation: < -110 dB, full frequency range.

Protection: Protected to 24V peak-to-peak.

Connectors: Rear-panel female BNCs labeled “Signal In”.

### **Distribution Outputs (1 through 10):**

Impedance: 50Ω, SWR: < 1.3.

Unity Gain: 0 dB, +/-1 dB.

Harmonics: < -45 dBc

Spurious: < -90 dBc.

Adjacent Output to Output Isolation: > 70 dB.

Protection: Outputs may be shorted to ground with no damage.

Connectors: Rear-panel female BNCs numbered 1 through 10.

### **External Alarm Input/Disable Inputs (A or B):**

Normal State: TTL low.

Alarm State: TTL high or high Z (internal 10kΩ pull-up).

Connectors: Rear-panel female BNCs labeled “Disable In”.

### **Alarm Output:**

Open-collector, 40 VDC Max, 100 mA Max Saturation Current.

High Impedance when any fault condition exists.

Connector: Rear-panel female BNC labeled “Alarm Out”.

### **Front-Panel System Status Indicators:**

Signal Input LEDs: Red/Green/Yellow LEDs indicate signal presence, selection status of each Signal Input and, if configured, Disable Input (external alarm input) status.

Signal Output LEDs: Red/Green/Yellow LEDs indicate signal presence status on each output.

Power LEDs: Red/Green LEDs indicate power supply status of each power input.

Alarm LED: Red/Green/Yellow LED indicates a serious fault condition.

### **Maintenance Port:**

See *RS-232 Serial I/O Port Signal Definitions* in *Chapter 3* for more information.

RS-232 serial I/O on rear panel DB9M jack for secure, local terminal access.

User-Selectable Parameters: 9600 to 57600 baud,

7 or 8 data bits,

odd, even or no parity,

1 or 2 stop bits

**Network I/O (Option):**

Rear-panel RJ-45 jack.  
10/100Base-T ethernet.

**Supported IPv4 Network Protocols (Option):**

TCP/IP  
SSH  
Telnet  
DHCP  
SNMP v1 and v2 with community strings. Limited implementation - MIB-II only.

**AC Power:**

90-264 VAC, 47-63 Hz, .5 A Max. @ 120 VAC, .25 A Max. @ 240 VAC.  
110-370 VDC, 0.5A Max @ 120 VDC.  
3-Pin IEC 320 on rear panel, 2 meter line cord is included.

**DC Power (Option):**

12 VDC (10-20 VDC), 5A maximum.  
24 VDC (19-36 VDC), 2.5A maximum.  
48 VDC (38-72 VDC), 1.5A maximum.  
125 VDC (70-160 VDC), 0.75A maximum.  
3-position terminal block on rear panel: +DC IN, SAFETY GROUND, -DC IN.  
(Floating power input: Either “+” or “-” can be connected to earth ground.)

**Size:**

Chassis: 1.75”H x 17.0”W x 10.75”D.  
Weight: < 5 lb. (2.70 kg.).

**Environmental:**

Operating Temperature:	0° to +50° C
Storage Temperature:	-40° to +85° C
Antenna Operating Temperature:	-40° to +85° C
Operating Humidity:	5% to 90%, RH, non-condensing
Storage Humidity:	5% to 95%, RH, non-condensing
Maximum Operating Altitude:	AC: 13,125 ft. / 4000 meters
	12/24 VDC: 13,125 ft. / 4000 meters
	48 VDC (<61 VDC Max.): 13,125 ft. / 4000 meters
	48 VDC (>60 VDC Max): 6,562 ft. / 2000 meters
	125 VDC: 6,562 ft. / 2000 meters

**Compliance:**

CE, FCC, RoHS, WEEE.

# SPECIFICATIONS

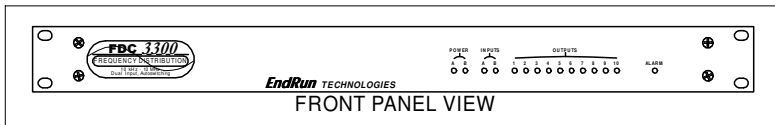
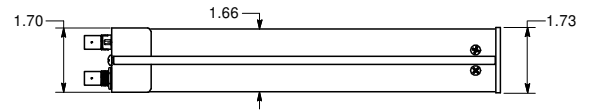
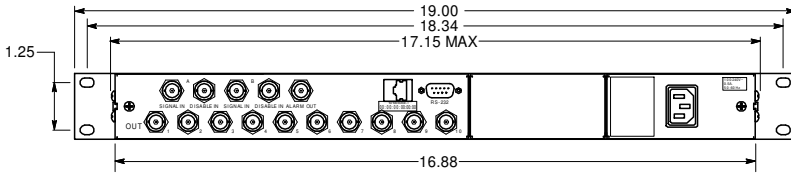
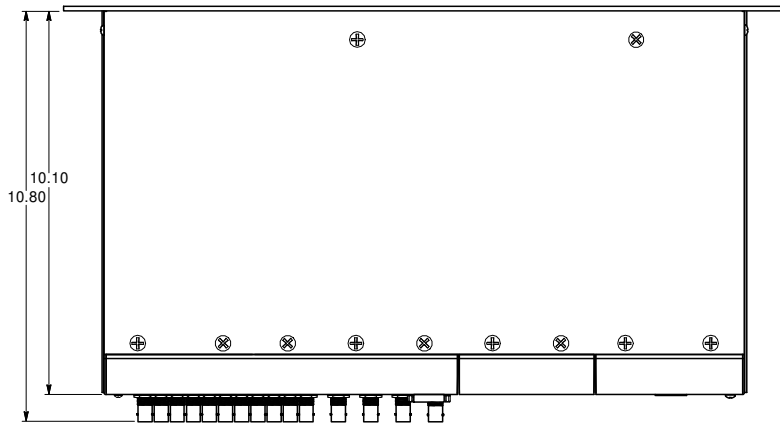

## FDC3300 DIMENSIONS - AC POWER



*EndRun*  
TECHNOLOGIES

## **DECLARATION OF CONFORMITY**

(According to ISO/IEC GUIDE 22 and EN 45014)

Manufacturer's Name: EndRun Technologies Inc.

Manufacturer's Address: 2270 Northpoint Parkway, Santa Rosa, California 95407, U.S.A.

### ***DECLARES, THAT THE PRODUCT***

Product Name: Pulse, Frequency and Timecode Distribution Chassis

Model Number: FDC3300, PDC3301, FDC3302 and TDC3303

### ***CONFORMS TO THE FOLLOWING EUROPEAN DIRECTIVES***

Low Voltage Directive: 2006 / 95 / EC  
R&TTE Directive: 1999 / 5 / EC  
EMC Directive: 2004 / 108 / EC  
RoHS Directive: 2011 / 65 / EC  
WEEE: 2012 / 19 / EC

#### Supplementary Information:

Safety: EN 60950-1:2006/A11:2009/A1:2010/A12:2011

EMC: EN 55022:2006 w/A1, Class A

EN 50024:1998 w/A1:2001 & A2:2003

EN 61000-3-2:2006 w/A1 & A2

EN 61000-3-3:2008

VCCI V-3 (2010) Class A

FCC Part 15 Subpart B Sect 15.107 Class A / ANSI C63.4(2003)

FCC Part 15 Subpart B Sect 15.109 Class A / ANSI C63.4(2003)

CISPR 22 (2008) Class A / ANSI C63.4 (2003)

Year Mark First Applied: 2008

I, the undersigned, hereby declare that the equipment specified above conforms to the above Directives and Standards.

Place: Santa Rosa CA USA

Date: 3/3/2014

Signature:

Full Name: David J. Lobsinger

Position: V. P. Hardware Engineering



# Special Modifications

---

## *Changes for Customer Requirements*

*From time to time EndRun Technologies will customize the standard FDC3300 Frequency Distribution Chassis for special customer requirements. If your unit has been modified then this section will describe what those changes are.*

**This section is blank.**

---

**SPECIAL MODIFICATIONS**



**EndRun**  
**TECHNOLOGIES**

*"Smarter Timing Solutions"*

2270 Northpoint Parkway  
Santa Rosa, CA 95407  
TEL 1-877-749-3878  
FAX 707-573-8619  
[www.endruntechnologies.com](http://www.endruntechnologies.com)

