

# **RTM3205** *Precision Timing Module*

---

*GPS-Synchronized*



## *User Manual*



---

# RTM3205 GPS

## *Precision Timing Module User Manual*

### **Preface**

Thank you for purchasing the RTM3205 Precision Timing Module. Our goal in developing this product is to provide an extremely accurate time and frequency standard referenced to Coordinated Universal Time (UTC) that you can deploy quickly, easily and reliably. Your new RTM3205 is fabricated using the highest quality materials and manufacturing processes available today, and will give you years of troublefree service.

### **About EndRun Technologies**

EndRun Technologies has been dedicated to the development and refinement of the technologies required to fulfill the demanding needs of the time and frequency community since 1998.

The instruments produced by EndRun Technologies have been selected as the time and frequency reference for such rigorous applications as enterprise computer synchronization, research institutions, aerospace, network quality-of-service monitoring, satellite earth stations, and calibration laboratories.

### **Trademark Acknowledgements**

Linux, UNIX, and Windows are registered trademarks of the respective holders.

### **EndRun Contact Information**

Address: EndRun Technologies  
2270 Northpoint Parkway  
Santa Rosa, CA 95407  
U.S.A.  
Phone: (707)573-8633  
Fax: (707)573-8619  
Sales: 1-877-749-3878 or (707)573-8633  
sales@endruntechnologies.com  
Support: 1-877-749-3878 or (707)573-8633  
support@endruntechnologies.com

Part No. USM3205-0000-000 Revision 5  
September 2021

Copyright © EndRun Technologies 2017-2021

---

## About This Manual

This manual will guide you through simple installation and set up procedures.

**Introduction** – The RTM3205, how it works, where to use it, its main features.

**Basic Installation** – How to connect, configure and test your RTM3205 with your network.

**NTP Server and Client Set-Up** – Two client sections; one for Unix-like platforms and one for Windows.

**Network Protocols** - Covers Security, SNMP, HTTPS, IPv6 and PTP/IEEE-1588.

**Console Port** – Description of the console commands for use over the network and serial ports.

**Options** – Description of any optional features that your RTM3205 might have.

If you detect any inaccuracies or omissions, please inform us. EndRun Technologies cannot be held responsible for any technical or typographical errors and reserves the right to make changes to the product and manuals without prior notice.

## Warranty

This product, manufactured by EndRun Technologies, is warranted against defects in material and workmanship for a period of two years from date of shipment, under normal use and service. During the warranty period, EndRun will repair or replace, at its option, products which prove to be defective. Products not manufactured by EndRun Technologies are warranted for ninety days or longer, as provided by the original equipment manufacturer, from date of shipment.

## Extended Warranty

EndRun products are supported by a strong, comprehensive standard warranty (see paragraph above). Extended warranties are available to expand the coverage period. The extended warranty can be purchased at the time of order, or during the last year of the standard warranty period.

## Limitation of Warranty

The foregoing express warranty shall not apply to defects resulting from improper or inadequate maintenance by Buyer or User, Buyer-supplied software or interfacing, unauthorized modification or misuse, operation outside of the environmental specifications for the product, or improper site preparation or maintenance.

TO THE EXTENT PERMITTED BY LAW, THIS WARRANTY AND REMEDIES SET FORTH ABOVE ARE EXCLUSIVE AND IN LIEU OF ALL OTHER WARRANTIES, REMEDIES AND CONDITIONS, WHETHER ORAL OR WRITTEN, STATUTORY, EXPRESS, OR IMPLIED. AS PERMITTED BY APPLICABLE LAW, ENDRUN SPECIFICALLY DISCLAIMS THE IMPLIED WARRANTIES OF MERCHANTABILITY OR FITNESS FOR A PARTICULAR PURPOSE.

---

## **Warranty Repair**

If you believe your equipment is in need of repair, contact EndRun Customer Support. It is important to contact us first as many problems may be resolved by phone or email. Please provide the serial number of the unit and the nature of the problem. If it is determined that your equipment will require service, we will issue an RMA number and specific shipping instructions.

Ship the unit prepaid in the original container or a container of sufficient strength and protection to EndRun Technologies. EndRun will not be responsible for damage incurred during shipment to us. Buyer shall prepay shipping charges to send product to EndRun and EndRun shall pay shipping charges to return product to Buyer. However, if returned product proves to be operating normally (not defective) then Buyer shall pay for all shipping charges. If Buyer is located outside the U.S.A. then Buyer shall pay all duties and taxes, if any.

Be sure the RMA number is clearly identified on the outside of the shipping container. Our policy is to repair the unit within 5 business days. If it is necessary to order parts or if other circumstances arise that require more than 5 days, an EndRun service technician will contact you.

Loaner units are not included as part of the standard warranty.

## **Repair After Warranty Expiration**

If the warranty period has expired, we offer repair services for equipment you have purchased from EndRun. Contact EndRun Customer Support. It is important to contact us first as many problems may be resolved by phone or email. Please provide the serial number of the unit and the nature of the problem. If it is determined that the equipment has failed and you want EndRun to perform the repairs, we will issue you an RMA number and specific shipping instructions.

Ship the unit prepaid in the original container or a container of sufficient strength and protection to EndRun Technologies. EndRun will not be responsible for damage incurred during shipment to us. Customer is responsible for shipping costs to and from EndRun Technologies. Be sure the RMA number is clearly identified on the outside of the shipping container. After the equipment has been received we will evaluate the nature of the problem and contact you with the cost to repair (parts and labor) and an estimate of the time necessary to complete the work.

## **Limitation of Liability**

The remedies provided herein are Buyer's sole and exclusive remedies. EndRun Technologies shall not be liable for any direct, indirect, special, incidental or consequential damages, whether based on contract, tort or any other legal theory.

---

This page intentionally left blank.

---

# Table of Contents

Preface .....	i
About EndRun Technologies .....	i
Trademark Acknowledgements .....	i
EndRun Contact Information .....	i
About This Manual .....	ii
Warranty .....	ii
Extended Warranty .....	ii
Limitation of Warranty .....	ii
Warranty Repair .....	iii
Repair After Warranty Expiration .....	iii
Limitation of Liability .....	iii
<b>Chapter One - Introduction .....</b>	<b>1</b>
Main Features .....	1
Robust GPS Receiver .....	1
Highly-Reliable, Modular Design .....	1
Standard Features .....	2
Additional Outputs .....	2
Secure Network Interface .....	2
Free FLASH Upgrades .....	2
Time Synchronization Components .....	2
GPS Timing-How It Works .....	3
Where to Use It .....	4
Client/Slave Software .....	4
<b>Chapter Two - Basic Installation .....</b>	<b>5</b>
Checking and Identifying the Hardware .....	5
RTM3205 Physical Description .....	6
Performing a Site Survey .....	7
Installing the RTM3205 .....	8
Connecting and Configuring Ethernet .....	9

Configuring Ethernet with the Serial Port .....	9
Connect the RS-232 Serial I/O Port .....	9
Test the Serial Port .....	10
Using netconfig to Set Up Your IP .....	11
Verify Network Configuration .....	12
Check Network Operation .....	14
Using Telnet .....	14
Using SSH .....	15
Using HTTPS .....	15
Connecting Instruments to the RTM3205 .....	16
<b>Chapter Three - Console Port Control and Status .....</b>	<b>17</b>
Console Ports .....	17
General Linux Operation .....	17
Available User Commands .....	18
Detailed Command Descriptions .....	21
accessconfig .....	21
anfltmask .....	21
caldelay .....	22
clearalmanac .....	22
cpuio .....	22
cpuioconfig .....	22
cpustat .....	22
dumpalmanac .....	23
dumpephemeris .....	23
faultstat .....	24
get_sw_opts .....	24
gpsdynmode .....	24
gpsionoinfo .....	25
gpslastfix .....	25
gpsrefpos .....	25
gpsrefpos_ecef .....	25
gpsstat .....	26
gpstrkstat .....	27



---

gpsutcinfo	28
gpsversion	28
help	28
inetdconfig	29
inhibitoutputsmode	29
installed_sw_opts	29
ionostat (Optional)	29
kernelversion	29
logrinex	29
netconfig	30
ntpconfig	30
ntpstat	31
oscctrlstat	31
passwd	33
ptpconfig0 and ptpconfig1 (Optional)	33
ptpstat0 and ptpstat1 (Optional)	33
rcvrserialnumber	33
rcvrstat	33
rcvrversion	33
resetlastgpswn	33
resetleaphistory	34
rticmode (Optional)	34
serialnumber	34
setantfltmask	34
setcaldelay	34
setgpsdynmode	34
setgpsrefpos	35
setinhibitoutputsmode	35
setrticmode (Optional)	35
setsigfltmask	35
settfomfltlvl	35
sigfltmask	36
subsysreset	36

syskernel	36
sysosctype	36
sysrootfs	36
sysstat	37
systemio	38
systemioconfig	38
systemmode	38
systemmodeconfig	38
sysversion	39
tfomfltlvl	39
triggerppo (Optional)	39
updatekernelflag	39
updaterootflag	39
upgradkernel	40
upgradercvr	40
upgradercvrfpga	40
upgraderootfs	40
upgradesubsys	40
wrt_sw_opt	41

<b>Chapter Four - Hyper Text Transfer Protocol Secure (HTTPS)</b>	<b>43</b>
HTTPS Interface Description	44
Navigation	45
Page Descriptions	45
Home: Overall Status Page	45
Home: User Manual	46
Home: Logout	46
Plots Page	46
Receiver: Receiver Page	47
Receiver: Oscillator Page	50
Clock Page	50
I/O Page	51
Faults: System Faults Page	51
Faults: Fault Mask Page	51

Faults: TFOM Fault Level Page . . . . .	51
Faults: Receiver Faults Page . . . . .	52
Network: IPv4 Page . . . . .	52
Network: IPv6 Page . . . . .	52
Network: DNS Page . . . . .	52
Network: MAC Address Page . . . . .	52
NTP Page . . . . .	52
PTP: Status and Configuration Pages . . . . .	53
Firmware: Firmware Status Page . . . . .	53
Firmware: Linux RFS Upgrade Page . . . . .	53
Firmware: Linux Kernel Upgrade . . . . .	53
Firmware: GPS Subsystem Upgrade Page . . . . .	53
Firmware: GPS Receiver Upgrade Page . . . . .	54
Firmware: Reboot Page . . . . .	54
Disable or Restrict Access . . . . .	54
<b>Chapter Five - Security . . . . .</b>	<b>55</b>
Linux Operating System . . . . .	55
Restrict Access . . . . .	56
Restrict Access - Telnet, SSH and SNMP . . . . .	56
Restrict Access - HTTPS . . . . .	57
Restrict Query Access - NTP . . . . .	58
Disable Protocols . . . . .	59
Disable Telnet, Time and Daytime . . . . .	59
Disable SNMP, SSH and HTTPS . . . . .	59
Re-Enable SNMP, SSH and HTTPS . . . . .	59
Is the Protocol Disabled? . . . . .	60
OpenSSH . . . . .	60
Configure Keys . . . . .	60
HTTPS . . . . .	61
Configure Certificate and Key . . . . .	61
NTP . . . . .	62
Network Security Vulnerabilities . . . . .	62

---

<b>Chapter Six - Simple Network Management Protocol (SNMP)</b> .....	63
SNMPv3 Security .....	63
Enterprise Management Information Base (MIB) .....	64
Invocation of the SNMP daemon .....	64
Quick Start Configuration -- SNMPv1/v2c .....	64
Change Default Community Strings (Passwords) .....	65
Configuring SNMPv1 Trap Generation .....	65
Configuring SNMPv2c Notifications and Informs .....	65
Configuration of SNMPv3 .....	66
Configuring SNMPv3 Notifications and Informs .....	67
Example of usmUser Record .....	68
Disable or Restrict Access .....	68
<b>Chapter Seven - Network Time Protocol (NTP)</b> .....	69
Configuring the NTP Server .....	69
Configuring the RTM3205 as a Stratum 1 Server .....	69
Configuring NTP Using the Network Interface or Serial Port .....	70
Configuring the RTM3205 as a Stratum 2 Server .....	72
Edit ntp.conf File .....	72
Mask Alarm .....	73
Setting Up NTP Clients on Unix-like Platforms .....	73
Unix-like Platforms: Basic NTP Client Setup .....	73
Configure NTP .....	74
Unix-like Platforms: MD5 Authenticated NTP Client Setup .....	74
Create the ntp.keys File .....	75
Configure NTP .....	75
Unix-like Platforms: Broadcast/Multicast NTP Client Setup .....	76
Configure NTP Client for Broadcast .....	76
Configure NTP Client for Multicast .....	77
Test Broadcast/Multicast .....	77
Setting Up NTP Clients on Windows .....	78
Windows: W32Time .....	78
Security .....	78

<b>Chapter Eight - IPv6 Information</b> .....	81
IPv6 Capabilities .....	81
OpenSSH .....	81
Apache HTTP .....	81
Net-SNMP .....	81
NTP .....	82
IPv4-Only Protocols .....	82
<b>Chapter Nine - Optional Precision Time Protocol (PTP/IEEE-1588)</b> .....	83
Software Option .....	83
About PTP .....	83
Two Gigabit Ports .....	84
PTP Configuration and Status .....	84
Default PTP Configuration Settings .....	84
PTP Configuration Using the Network or Serial Port .....	85
PTP Status Using the Network or Serial Port .....	86
PTP Operation .....	87
About the PTP Second and UTC Time .....	89
PTP Second .....	89
UTC Time .....	89
Multiport PTP .....	90
Disable the PTP Protocol .....	90
Re-Enable PTP .....	90
<b>Chapter Ten - Inputs/Outputs (I/O)</b> .....	91
Standard I/O .....	91
Antenna Jack .....	91
Ethernet Ports .....	91
Serial I/O Port .....	91
DC Power Input Jack .....	91
Output Options .....	91
1 PPS Option .....	92
Time Code Option (AM or DC) .....	93
Programmable Pulse Output (PPO) Option .....	93

Trigger PPO Function .....	94
Direct Digital Synthesizer (DDS) Option .....	95
10 MPPS Option .....	95
Alarm Option .....	96
10 MHz Low-Phase-Noise Option .....	96
<b>Chapter Eleven - Real-Time Ionospheric Corrections (RTIC) Option .....</b>	<b>97</b>
Software Option .....	97
About RTIC .....	97
Ionospheric Delay and Impact To GPS Time-Transfer .....	97
Our Proprietary Solution .....	98
Performance Verified at National Institute of Standards and Technology (NIST) .....	99
RTIC Configuration and Status .....	100
RTIC Configuration and Status Using the Network or Serial Port .....	100
ionostat .....	100
rticmode .....	100
setrticmode .....	101
RTIC Performance Plots Using the HTTP Interface .....	101
RTIC Stability Specifications .....	102
<b>Chapter Twelve - Optional Synchronous Ethernet (SyncE) .....</b>	<b>103</b>
Software Option .....	103
About SyncE .....	103
Operation .....	104
Status .....	104
Disable the SyncE Protocol .....	104
Re-Enable SyncE .....	105
<b>Appendix A - Time Figure of Merit (TFOM) .....</b>	<b>107</b>
<b>Appendix B - Upgrading the Firmware .....</b>	<b>109</b>
Upgrade via the HTTPS Interface .....	109
Upgrade via the Console Port .....	111
Performing the Linux RFS Upgrade .....	111
Transfer File to RTM3205 .....	111

Recovering from a Failed RFS Upgrade .....	113
Performing the Linux Kernel Upgrade .....	113
Transfer File to RTM3205 .....	113
Recovering from a Failed Kernel Upgrade .....	114
Performing the GPS Subsystem Upgrade .....	115
Problems with the GPS Subsystem Upgrade .....	116
Performing the GPS Receiver Upgrade .....	116
Problems with the GPS Receiver Upgrade .....	117
Performing the GPS Receiver FPGA Upgrade .....	117
<b>Appendix C - Helpful Linux Information .....</b>	<b>119</b>
Linux Users .....	119
Linux Commands .....	119
Detailed Information Is Available .....	119
Change Password .....	120
List Active Processes .....	120
NTP Monitoring and Troubleshooting .....	120
Text Editors .....	121
Change Log-In Banners .....	121
Query and Change Ethernet Ports .....	122
Redirect Syslog Files to Remote Host .....	122
<b>Appendix D - Third-Party Software .....</b>	<b>123</b>
GNU General Public License .....	123
NTP Software License .....	124
Apache Software License .....	125
PTP Software License .....	126
<b>Appendix E - Installing the GPS Antenna .....</b>	<b>127</b>
Antenna Location .....	127
GPS Antenna Kit .....	128
About Coax Cable .....	128
Long Cable Runs .....	129
Recommended Cable .....	129
Using GPS Low-Noise Amplifiers (LNAs) .....	129

Using Two or Three LNAs	130
<b>Other Accessories</b>	<b>131</b>
Lightning Arrestor	131
Signal Splitters	131
Calibrate Your Receiver	132
Mounting On A Rooftop	133
Obtaining A Reference Position	133
About WGS-84 Height	133
<b>Appendix F - Leap Seconds</b>	<b>137</b>
Automatic Leap Second Insertion	137
Background Information	137
<b>Appendix G - System Faults</b>	<b>139</b>
Overview	139
Masking Faults	139
System Fault Definitions	139
Receiver Fault Definitions	140
<b>Appendix H - Time Code Formats</b>	<b>143</b>
IRIG-B122/002	143
IRIG-B123/003	143
IRIG-B120/000 (IEEE-Standard 1344-1995)	143
NASA-36	143
2137	143
IEEE-1344 Bit Definition	144
<b>Appendix I - Software Options</b>	<b>145</b>
wrt_sw_opt	145
get_sw_opts	145
installed_sw_opts	145
Software Option Bit Definitions	146
<b>Appendix J - Operation with a GPS Simulator</b>	<b>147</b>
Background	147



---

Console Port Commands .....	147
clearalmanac .....	147
resetlastgpswn .....	148
resetleaphistory .....	149
<b>Appendix K - Specifications .....</b>	<b>151</b>
Software Options .....	154
System Oscillator .....	154
Optional Outputs .....	155
Compliance .....	157
<b>Special Modifications - Changes for Customer Requirements .....</b>	<b>159</b>

---

This page intentionally left blank.

# Chapter One

## Introduction

*The RTM3205 Precision Timing Module provides highly-precise time and frequency outputs in a compact, portable module. Optimized for size, weight and power (SWaP), the RTM3205 requires only 68 cubic inches of mounting space and consumes less than 10 watts of power.*

*Using a proprietary Global Positioning System (GPS) timing receiver, the RTM3205 supports operation in static or dynamic (shipboard only) platforms. Proprietary multiple satellite optimal ensemble, adaptive 3rd order frequency control and TRAIM algorithms maximize the accuracy, stability, and reliability of the output signals. A variety of top-quality quartz oscillators are available to handle the full range of holdover, phase noise, and short-term stability requirements. Units equipped with our Ultra-Stable OCXO provide unmatched close-in phase noise performance and short-term stability.*

*The RTM3205 uses the GPS transmissions to precisely synchronize itself to within 10 nanoseconds of Coordinated Universal Time (UTC). The frequency of the internal oscillator is disciplined to match the frequency of the UTC timescale to less than 1 part in  $10^{13}$  over 24-hour observation intervals. The time and frequency outputs are coherent after initial GPS synchronization, and synchronization is maintained via 20-bit DAC frequency control, rather than phase stepping, to provide excellent short-term stability.*

*For more detailed information that is not included in this manual, and links to other sites, please visit our website: <http://www.endruntechnologies.com>. There you can also download firmware upgrades, the latest manuals and other documentation.*

## Main Features

### Robust GPS Receiver

RTM3205 is a GPS-based time and frequency standard designed to support mission critical applications. The proprietary GPS timing receiver in RTM3205 has many safe guards to protect against false GPS signals. The receiver strictly adheres to the GPS Interface Specification and performs low-level integrity checks to protect against weak corrupted signals, jamming, spoofing and accidental GPS control system errors. EndRun's GPS timing receiver technology has evolved to be highly robust against these threats to provide time and frequency outputs you can trust.

### Highly-Reliable, Modular Design

The RTM3205 provides high performance and reliability combined with small size and low power consumption. Its internal sub-assemblies are fabricated using state-of-the-art components and pro-

cesses and are integrated in a solid, high-quality chassis. Since it uses highly efficient ARM microprocessors, the RTM3205 is convection-cooled and the chassis is sealed to eliminate the maintenance and reliability issues associated with fan-cooled architectures. Air currents flowing over sensitive frequency control components are also eliminated so that the extraordinary short-term stability available from the RTM3205 oscillators is preserved. Up to four outputs can be customer configured at the time of order supporting a range of analog and digital outputs. Details on the various outputs are described in *Chapter 10 - Inputs/Outputs (I/O)* and *Appendix K - Specifications*.

### **Standard Features**

The basic RTM3205 provides an RS-232 serial port and dual-gigabit Ethernet ports with a high-bandwidth Network Time Protocol (NTP) server. The RTM3205 can be managed via the network port or the serial port. See *Chapter 3 - Console Port Control and Status*, and *Chapter 7 - NTP* for more information.

### **Additional Outputs**

Up to four optional outputs are available via SMA connectors. Outputs supported include 10 MHz low-phase-noise, 1 PPS, pulse rates to 10 MPPS, time code (AM and DCLS), and an open-collector alarm.

### **Secure Network Interface**

Dual 10/100/1000Base-T Ethernet ports are provided as a standard feature of the RTM3205 with a wide variety of protocols including NTP, SNMP with Enterprise MIB, SSH, Telnet, FTP, HTTPS, and SNTP. Refer to *Chapter 2 - Basic Installation* for information to help you set up your network interface. The inclusion of SNMP v3 and SSH provides a very secure network interface and allows you to safely perform monitoring and maintenance activities over the network. Security-conscious users can also disable any or all of the risky protocols such as HTTPS, Telnet, Time and Daytime. In addition, access via SSH, SNMP and Telnet can be restricted to specific hosts. Refer to *Chapter 6 - SNMP* and *Chapter 5 - Security* for further information.

### **Free FLASH Upgrades**

Firmware and configurable hardware parameters are stored in non-volatile FLASH memory, so the RTM3205 can be easily and securely upgraded in the field using SSH and SCP or the local RS-232 serial port. Upgrades via FTP and Telnet are also possible although these protocols are not secure. We make all firmware upgrades to our products available to our customers free of charge. For firmware upgrade procedures refer to *Appendix B - Upgrading the Firmware*.

## **Time Synchronization Components**

The RTM3205 contains a GPS Subsystem composed of EndRun Technologies' proprietary GPS Receiver and a system quartz oscillator. All quartz oven controlled oscillators are EndRun Technologies' proprietary design as well, and provide state-of-the-art close-in phase noise and short-term stability. The GPS Subsystem is integrated with a fanless, convection-cooled high performance ARM CPU with two integrated Ethernet ports that provide NTP (and optionally IEEE 1588/PTP). This is called the Linux/NTP Subsystem. Figure 1 shows RTM3205's time synchronization components.

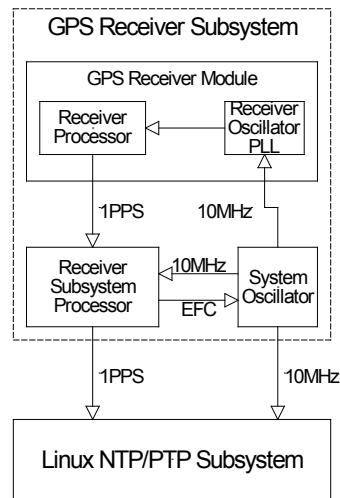

**FIGURE 1 - RTM3205 GPS SYSTEM TIMEBASE**

## GPS Timing-How It Works

The time and frequency engine in the RTM3205 receives transmissions from satellites that are operating in compliance with the Navstar GPS Interface Specification known as IS-GPS-200. It specifies the receiver interface needed to receive and demodulate the navigation and time transfer data contained in the GPS satellite transmissions. The GPS navigation system requires a means of synchronizing the satellite transmissions throughout the constellation so that accurate receiver-to-satellite range measurements can be performed via time-of-arrival measurements made at the receiver. For the purposes of locating the receiver, measurements of the times-of-arrival of transmissions from at least four satellites are needed for maximum timing accuracy. Time transfer to a receiver at a known position from a single satellite is supported,

The GPS system designers defined *system time* to be *GPS time*. GPS time is a monotonic time scale consisting of an ensemble of high-performance cesium beam and rubidium vapor atomic frequency standards located in the monitoring stations and satellites. GPS time is measured relative to UTC, as maintained by the United States Naval Observatory (USNO), and maintained synchronous with UTC(USNO) except that it does not suffer from the periodic insertion of leap seconds. Such discontinuities would unnecessarily complicate the system's navigation mission. Contained in the data transmitted from each satellite is the current offset between GPS time and UTC(USNO). This offset is composed of the current integer number of leap seconds difference and a small residual error that is typically less than +/- 10 nanoseconds.

Each satellite in the constellation contains redundant cesium beam or rubidium vapor atomic frequency standards. These provide the timebase for all transmissions from each satellite. These transmissions are monitored from ground stations located around the world and carefully measured relative to GPS time. The results of these measurements for each satellite (i.e. correction to GPS time) are then

uploaded to that satellite so that they may be incorporated into the data contained in its transmissions. The receiver can use this data to relate the time-of-arrival of the received transmissions from that satellite to GPS time and by using the transmitted UTC parameters, to UTC(USNO).

All of this means that during normal operation, the source of the timing information being transmitted from each of the satellites is directly traceable to UTC(USNO). Due to the nature of the GPS spread spectrum Code Division Multiple Access (CDMA) modulation scheme, this timing information may be extracted by a well-designed receiver with a precision of a few nanoseconds. The GPS time and frequency engine in the RTM3205 does just that.

## **Where to Use It**

Since signals from the GPS satellites are available at all locations on the globe, you may deploy the RTM3205 virtually anywhere. However, you must be able to install an antenna with good sky visibility, preferably on the rooftop.

## **Client/Slave Software**

RTM3205 has been designed to operate in conjunction with existing public domain NTP/SNTP client software and may be used in any network environment that is using TCP/IP protocols. Although client software is available for all platforms, for the most precise applications, the Unix-like operating systems are best supported. For more information see *Chapter 7 - NTP, Setting Up NTP Clients on Unix-like Platforms* and *Setting Up NTP Clients on Windows*. There is additional information about NTP Client software at this link:

<http://www.endruntechnologies.com/ntp-client.htm>

For PTP/IEEE-1588 applications, the RTM3205 can interoperate with a variety of Slave software and hardware. For more information on PTP Slave Software go to this link:

<http://www.endruntechnologies.com/ptp-slave.htm>

# Chapter Two

## *Basic Installation*

*This chapter will guide you through the most basic checkout and physical installation of your RTM3205 Precision Timing Module. See **Chapter 7 - NTP** for instructions on how to configure your unit as an NTP Server. See **Chapter 9 - PTP/IEEE-1588** for instructions on how to configure your unit as an optional PTP Grandmaster. Other chapters and appendices will give you the information needed to configure your installation for the maximum performance in your operating environment.*

*Basic familiarity with TCP/IP networking protocols like **ping**, **telnet** and **ftp** is required. Though some familiarity with Linux or other Unix-like operating systems would be helpful, it is not essential. If you satisfy these conditions, the instructions provided herein should guide you to a successful installation. For a brief description of some helpful Linux commands and utilities see **Appendix C - Helpful Linux Information**.*

### Checking and Identifying the Hardware

Unpack and check all the items using the shipment packing list. Contact the factory if anything is missing or damaged. The RTM3205 Precision Timing Module shipment typically contains:

- RTM3205 Precision Timing Module (part #3205-0001-000 or #3205- variant)
- RTM3205 User Manual (part #USM3205-0000-000) on CD (part #5102-0001-000)
- Basic Cable Kit (part # 0648-0002-000) including:
  - RJ-45 to RJ-45 CAT-5 patch cable, 2 meters
  - DB9F-to-DB9F null-modem serial I/O cable
- Antenna Kit (part # 0610-0009-001) including:
  - GPS antenna
  - Pipe/clamps for outside antenna mounting
  - 50' TNC/TNC RG-59/U coaxial cable assembly
- Starter Kit (part # 0608-0009-000) including:
  - SMA/TNC adaptor
  - DC power connector and crimp pins
  - 36" DC power cable

## RTM3205 Physical Description

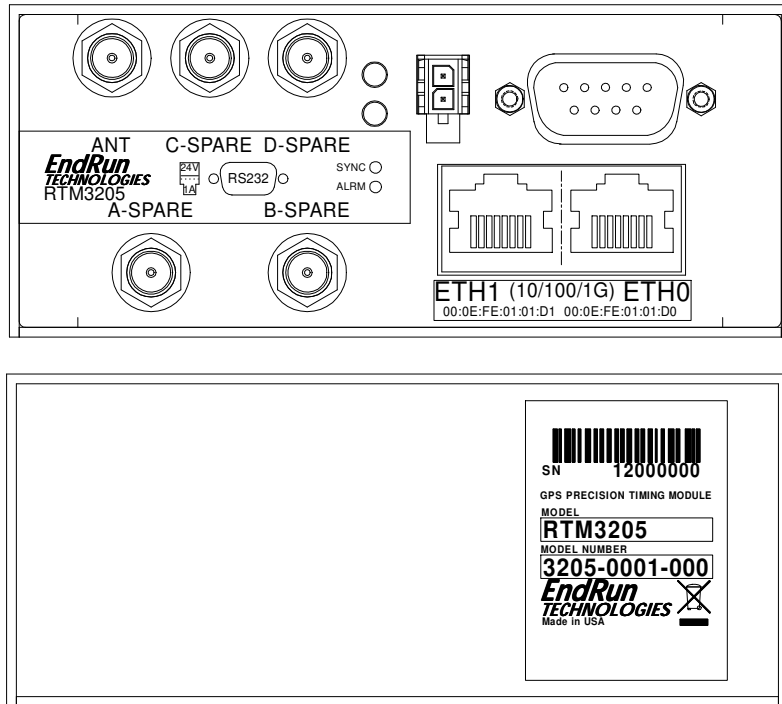

The drawings above shows the basic RTM3205 front and rear-panels with no optional outputs. For more information see *Chapter 10 - Inputs/Outputs*. (For a dimensional drawing of the RTM3205 chassis see *Appendix K - Specifications*.) Descriptions below briefly describe the standard and optional I/O connectors:

Sync LED	This amber LED flashes to indicate synchronization status.
Alarm LED	This red LED illuminates briefly at power-up, and thereafter whenever a serious fault condition exists.
GPS Antenna Input	This SMA connector mates with the download cable from the external antenna.
RS-232 Port	This DB9M connector provides the RS-232 serial I/O console interface to the RTM3205. This console allows you to initialize and maintain the RTM3205. See <i>Chapter 3 - Console Port Control and Status</i> for more information and <i>Appendix K - Specifications</i> for the RS-232 pin assignments.
10/100/1000Base-T Jacks	These two RJ-45 connectors mate with the Ethernet twisted pair cable from the network. They are labeled “ETH0” and “ETH1” with the corresponding MAC address. Integrated LEDs indicate link speed (green) and activity (amber). Both ports provide a console interface to the RTM3205. See <i>Chapter 3 - Console Port Control and Status</i> for more information.



DC Power Input Jack	This 2-position jack provides connection to the DC power source. See details in <i>Appendix K - Specifications</i> .
Spare Outputs	These unused SMA connectors are labeled “SPARE”. When used, they will be labeled with their connector identifier (A, B, C or D) and provide optional signals. Label examples are: “A-AMCODE”, “B-1 PPS”, or “C-PPO”. Various optional outputs are listed below. For details, see <i>Chapter 10 - Inputs/Outputs</i> . and <i>Appendix K - Specifications</i> : <ul style="list-style-type: none"><li>1 Pulse Per Second (PPS)</li><li>10M Pulses Per Second (PPS)</li><li>Amplitude-Modulated (AM) Time Code</li><li>DC-Level-Shift Time Code</li><li>Open-Collector Alarm</li><li>Programmable Pulse Output (PPO)</li><li>Direct Digital Synthesizer Pulse Rates (DDS)</li><li>10 MHz Low-Phase-Noise (LPN)</li></ul>

## Performing a Site Survey

Using the front panel status LED indicators, it’s easy to find out if your RTM3205 will work in your desired location:

1. Temporarily mount the antenna on the roof. Make sure that it is not blocked by large metallic objects closer than one meter. See *Appendix E - Installing the GPS Antenna* for more information.
2. Connect the TNC plug on the end of the antenna cable to the supplied TNC/SMA adapter. Connect the SMA plug end of the adapter to the antenna input jack on the RTM3205.
3. Connect the “+24VDC” terminal to the positive output of the DC power source. Connect the “GND” terminal to the negative output of the DC power source. The DC power source voltage must not exceed +32V. This unit will not operate if the +/- connections are reversed; however it will not be damaged by a reverse connection. Note that the GND terminal is connected to the chassis inside the unit.

Initially upon power up:

1. The unit will light the Alarm LED for about 10 seconds.
2. Then it will continuously light the Sync LED.
3. When the unit locks onto a GPS signal and begins to decode the timing data and adjust the system oscillator, the Sync LED will flash very rapidly (about a 6 Hz rate) until the data is fully decoded and the system oscillator is fully locked to the GPS frequency.

**NOTE**

RTM3205 has an OCXO oscillator (MS-OCXO, HS-OCXO, or US-OCXO) so it will require a 5-10 minute warm-up period before it begins searching for a GPS signal.

4. Then the Sync LED will pulse at precisely a 1 Hz rate, synchronized to UTC seconds.

At this point, the GPS Subsystem is fully synchronized, and you may proceed to permanently mounting the chassis and antenna in their desired locations. If you are unable to achieve GPS lock after 24 hours, then contact EndRun Customer Support for assistance.

**NOTE**

In order for the RTM3205 to synchronize with maximum accuracy to UTC, the delay for the cable and all devices between the antenna and the GPS receiver must be compensated. See *Appendix E - Installing the GPS Antenna, Calibrate Your Receiver* for more information.

## Installing the RTM3205

Mount the unit in the desired location. After mounting the unit and connecting the antenna cable, verify that it still acquires and tracks a GPS signal. Refer to the baseplate drawing in *Appendix K - Specifications* for the mounting hole locations.

**CAUTION**

Power cable is used as a disconnection device. To de-energize equipment, disconnect the power cable. Do not install the RTM3205 where the operating ambient temperature might exceed 122°F (50°C).

The RTM3205 internal temperature must not exceed 70°C, as measured by the built-in temperature sensor accessible via the "osctrlstat" serial port command. Internal temperature will remain in safe range if all conditions are met:

- A. Base plate is in good thermal contact with external enclosure.
- B. Ambient air temperature surrounding RTM3205 GPS Timing Module enclosure is < 50°C.
- C. Adequate clearance around RTM3205 enclosure allows for free-convection around cover.
- D. No additional thermal sources via adjacent mechanical contact.

Condition A must be met. If condition B and/or C and/or D cannot be met as stated, use built-in temperature sensor to verify adequate operating margins.

### **Connecting and Configuring Ethernet**

Connect one end of the CAT-5 patch cable supplied with your RTM3205 to either of the RJ-45 connectors labeled 10/100/1000BASE-T. Connect the other end of the patch cable to your network through a 'straight' port on your switch. Do not connect it to a 'crossover' port on your switch.

By factory default, the RTM3205 will attempt to configure the Ethernet interfaces automatically via the Dynamic Host Configuration Protocol (DHCP). The RTM3205 will attempt to set the netmask, its IP address, the IP address of the default gateway, the domain name and the IP addresses of any nameservers, if the DHCP server is configured to provide them. You may optionally configure the RTM3205 to also set its hostname via DHCP, if your DHCP server is configured to provide it. You can do this by running a simple script called **netconfig** after your unit is up on the network.

If your network *does* use DHCP for host configuration, and you are in a hurry to get your RTM3205 up and running, you may proceed to *Verifying Network Configuration* to make sure that the network parameters were set up correctly. Otherwise, it is recommended that you read the following sections on the use of the RS-232 serial I/O port now, since they will help you in debugging any problems that you may encounter with the automatic configuration via DHCP.

If your network *does not* use DHCP, you will need to configure your Ethernet interfaces using the RS-232 serial I/O port. The following sections contain brief descriptions on how to do that.

### **Configuring Ethernet with the Serial Port**

To configure your Ethernet interfaces with the serial port, after logging in as the *root* user, you must run a simple script called **netconfig**. This script will prompt you for the needed information and perform some syntax checking on your inputs. Then it will create or modify the appropriate files needed to configure the Ethernet interface. The following sections will guide you in setting up communications with the RTM3205 using its RS-232 serial I/O port.

#### **Connect the RS-232 Serial I/O Port**

To test serial communications with the RTM3205 you will need either a VT100 compatible terminal or a terminal emulation program running on your computer. We will refer to either of these as "terminal" for the remainder of this instruction.

1. Disconnect power from the RTM3205.
2. Connect one end of the DB9F-to-DB9F null modem adapter cable to the serial I/O jack on the RTM3205.
3. Connect the other end of the DB9F-to-DB9F null modem adapter cable to the terminal. If the serial I/O port on your terminal does not have a DB9M connector, you may need to use an adapter. Refer to *Appendix K - Specifications* for details on the signal wiring. *If you are using a computer for your terminal, remember which port you are using because you will need to know that in order to set up your terminal software.*

**NOTE**

You must use an RS-232 null-modem cable or adapter if you are connecting the RTM3205 to another computer. The cable included in the shipping kit is a null-modem cable.

If your computer does not have a serial port, you can use a USB port with a USB-RS232 converter similar to Gearmo GM-FTDI-8. First, connect the USB converter to your computer, then connect the converter to the null-modem cable. Finally, connect the null-modem cable to the RTM3205.

**Test the Serial Port**

You must configure your terminal to use the serial I/O port you used in *Connect the RS-232 Serial I/O Port* above. You must also configure your terminal as shown below:

- Baud Rate: 19200
- Data Bits: 8
- Parity: None
- Stop Bits: 1
- Handshaking / Flow Control: OFF (both hardware and software)
- Terminal Emulation (if any): VT100 (or similar) or Linux

After configuring these parameters in your terminal, apply power to the RTM3205. After about 20 seconds, your terminal should display something similar to this:

```
*****
* 6010-0066-000 Linux Bootloader v1.00 Jan  1 2013 21:24:16 *
*****

Default kernel: FACTORY
To override and boot the UPGRADE version of the kernel, type UPGRADE within 5 seconds
.....
  Booting with FACTORY Kernel

Default Root File System: FACTORY
To override and boot the UPGRADE version of the Root File System, type UPGRADE within 5 seconds
.....
  Booting with the FACTORY Root File System
```

These lines are the Linux bootloader boot prompts. These prompts will timeout after five seconds and the factory default Linux kernel and the factory default RTM3205 root file system will be loaded. When the Linux kernel is loaded from FLASH memory into RAM a long list of kernel-generated, informational messages is displayed as the kernel begins execution and the various device drivers are initialized. When the boot process completes, the RTM3205 login prompt is displayed:

```
*****
*           Welcome to RTM3205 GPS console on:  RTM3205.your.domain
*           Tue Feb 20  2013 21:47:03 UTC
*****

RTM3205 login:
```

Here you may log in as “sysuser” with password “Praecis” or you may log in as the “root” user with password “endrun\_1”. When logged in as “sysuser”, you may check status information and view log

files but you will not be able to modify any system settings or view secure files. In order to perform system setup procedures, which includes configuring the IP network settings, you must log in as the “root” user. After correctly entering the password at this prompt,

**password:**

the sign on message is shown. It identifies the host system as RTM3205 and shows the software part number, version and build date. The out-of-the-box hostname is set to “RTM3205”, and the domain-name is set to “your.domain”.

```
RTM3205 GPS 6010-0069-000 v 1.00 Sat Jan 19 14:17:44 UTC 2013
RTM3205 GPS (root@RTM3205:~)->
```

This last line is the standard RTM3205 prompt. After configuring the unit, you should change the passwords using the Linux **passwd** command issued from the prompt.

If you do not see characters displayed by your terminal program within 30 seconds after the unit is powered up, you must troubleshoot your setup. An incorrectly wired cable or incorrect port setting in your terminal emulation program are the most common problems. Refer to *Appendix K - Specifications* for the signal connections for the RTM3205.

Once you have successfully established communications with the RTM3205, you may proceed to configure the network parameters using **netconfig** (see below). Then you can communicate with the RTM3205 over the network using **telnet** or **ssh** and synchronize your network computers to UTC using NTP.

### Using netconfig to Set Up Your IP

#### NOTE

When setting up the IP addresses on both network port 0 (eth0) and 1 (eth1):

1. Be sure that they are NOT on the same subnet.
2. Configure the default gateway on either port 0 (eth0) or port 1 (eth1), but NOT both.

#### NOTE

If you want to use the HTTPS Interface, then be sure to configure the name server IP address during the **netconfig** process. The HTTPS Interface will not operate properly if this is configured incorrectly. Only one name server is required, but two gives some redundancy.

The following shows the beginning of the **netconfig** interactive script:

```

*****
***** RTM3205 GPS IPV4/IPV6 Network Configuration *****
*****
*
* This script will configure the TCP/IPV4/IPV6 network parameters for your *
* RTM3205 GPS. We will first configure IPV4 and then IPV6. Your *
* RTM3205 GPS has two Ethernet interfaces, called eth0 and eth1. For *
* each of IPV4 and IPV6, we will first configure eth0 and then eth1. *
*
* You can choose to keep the existing configuration of either interface and *
* reconfigure the other. You can also choose to "unconfigure" either of *
* the two interfaces if both are not needed in your application. *
*
* You will be able to reconfigure your system at any time by typing: *
*
* netconfig *
*
* The settings you make now will not take effect until you reboot your *
* RTM3205 GPS, so if you make a mistake, just re-run this script before *
* rebooting. *
*
* You will be prompted to enter your IPV4/IPV6 network parameters now. *
*
*****
*****
Configure IPV4 for either eth0 or eth1?
  (Answer yes to continue on and reconfigure either eth0 or eth1 for IPV4.)
  (Answer no to "unconfigure" both eth0 and eth1 for IPV4. Only the
   IPV4 loopback interface will be setup.) ([y]es, [n]o):

```

After configuring your Ethernet interfaces, you should shutdown the RTM3205 and reboot it by issuing this command at the prompt:

```
RTM3205 GPS(root@RTM3205:~)-> reboot
```

### Verify Network Configuration

If you are using the RS-232 serial I/O port to communicate with the RTM3205, you will be able to see the kernel-generated boot messages when the unit reboots. You should note the lines

```
Configuring eth0 as 192.168.1.120...
Configuring eth1 as 192.168.5.1...
```

if you have set up a static IP address, or these lines

```
Attempting to configure eth0 by contacting a DHCP server...
Attempting to configure eth1 by contacting a DHCP server...
```

if you are using DHCP. These appear near the end of the kernel generated boot messages.

If you are using DHCP and are not using the RS-232 serial I/O port, you will have to check the DHCP configuration information maintained by your DHCP server to determine the expected IP address and log in to the RTM3205 using **telnet** or **ssh** to verify successful DHCP configuration. Refer to the subsequent topics in this section *Using Telnet* and *Using SSH*, for details on logging in to the RTM3205 that way. Once you have logged in, you may perform the following checks.

---

## BASIC INSTALLATION

If you are not using DHCP, the IP address shown should match the static IP address which you entered during the `netconfig` procedure. If so, log in as “root” at the login prompt and check the other configuration parameters using `ifconfig`:

```
RTM3205 GPS(root@RTM3205:~)-> ifconfig

eth0      Link encap:Ethernet  HWaddr 00:0e:fe:01:00:1c
          inet addr:192.168.1.120  Bcast:192.168.1.255  Mask:255.255.255.0
          UP BROADCAST RUNNING MULTICAST  MTU:1500  Metric:1
          RX packets:9694 errors:0 dropped:970 overruns:0 frame:0
          TX packets:459 errors:0 dropped:0 overruns:0 carrier:0
          collisions:0 txqueuelen:1000
          RX bytes:829805 (810.3 KiB)  TX bytes:50242 (49.0 KiB)
          Interrupt:11

eth1      Link encap:Ethernet  HWaddr 00:0e:fe:01:00:1d
          inet addr:192.168.5.1  Bcast:192.168.5.255  Mask:255.255.255.0
          UP BROADCAST RUNNING MULTICAST  MTU:1500  Metric:1
          RX packets:10143 errors:0 dropped:970 overruns:0 frame:0
          TX packets:0 errors:0 dropped:0 overruns:0 carrier:0
          collisions:0 txqueuelen:1000
          RX bytes:881081 (860.4 KiB)  TX bytes:0 (0.0 B)
          Interrupt:15

lo        Link encap:Local Loopback
          inet addr:127.0.0.1  Mask:255.0.0.0
          inet6 addr: ::1/128 Scope:Host
          UP LOOPBACK RUNNING  MTU:16436  Metric:1
          RX packets:5808 errors:0 dropped:0 overruns:0 frame:0
          TX packets:5808 errors:0 dropped:0 overruns:0 carrier:0
          collisions:0 txqueuelen:0
          RX bytes:728178 (711.1 KiB)  TX bytes:728178 (711.1 KiB)
```

Pay particular attention to the settings shown for `eth0` and `eth1`, in particular the `Mask:` setting, which should match that which is appropriate for your network. Now check the remaining configuration parameters using `route`:

```
RTM3205 GPS(root@RTM3205:~)-> route
Kernel IP routing table
Destination    Gateway         Genmask         Flags Metric Ref    Use Iface
default        192.168.1.1    0.0.0.0         UG    1     0      0 eth0
loopback      *               255.0.0.0       U     0     0      0 lo
localnet      *               255.255.255.0   U     0     0      0 eth0
192.168.5.0   *               255.255.255.0   U     0     0      0 eth1
```

Here you are interested in the default gateway address. It should match the appropriate one for your network. If so, then the Ethernet interface of your RTM3205 has been successfully configured to operate on your network and you are ready to check operation of the RTM3205 over the network. If not, you should recheck your configuration and/or repeat the `netconfig` procedure.

If you have configured a nameserver(s) for your network, you may check that by issuing this command:

```
RTM3205 GPS(root@RTM3205:~)-> cat /etc/resolv.conf
search your.domain
nameserver 192.168.1.1
nameserver 192.168.1.2
```

Which displays the contents of the `/etc/resolv.conf` file containing the domain name you entered previously using `netconfig`, and the nameserver IP address(es) to use for that domain.

### Check Network Operation

With your RTM3205 network parameters properly configured, you are ready to test the setup using `ping` from a server or workstation that is able to access the network connected to the RTM3205. Alternatively, you could `ping` one of your servers or workstations from the RTM3205 prompt to test the setup.

Once you have successfully established network communications with the RTM3205, you may perform all maintenance and monitoring activities via `telnet` and `ftp`. The RTM3205 provides both client and server operation using `telnet`. For security reasons, only client operation is supported using `ftp`. You may also monitor the RTM3205 via the HTTPS interface (see *Chapter 7 - HTTPS*).

Security conscious users will want to use `ssh`, the secure shell replacement for `telnet`, as the login means. The companion utility, `scp` provides a secure replacement for `ftp` as a means of transferring files to and from the RTM3205. Both of these protocols are supported in the RTM3205 via the OpenSSH implementations for Linux. Refer to *Chapter 5 - Security, OpenSSH* for more information about the secure shell protocol.

### Using Telnet

When establishing a `telnet` connection with your RTM3205, logging in directly as `root` is not permitted. This is a security measure that makes it slightly more difficult to gain access by simply trying passwords, since it is also necessary to know the name of a user. When you initiate a `telnet` session with the RTM3205, this banner will be displayed:

```
*****  
*           Welcome to RTM3205 GPS telnet console on:  host.your.domain  
*****
```

`host login:`

Here you may log in as “sysuser” with password “Praecis”. When logged in as “sysuser”, you may check status information and view log files but you will not be able to modify any system settings or view secure files. After correctly entering the password at this prompt,

`Password:`

the sign on message is shown. It identifies the host system as RTM3205 GPS and shows the software part number, version and build date:

```
RTM3205 GPS 6010-0069-000 v 1.00 Sat Jan 19 14:17:44 UTC 2013  
RTM3205 GPS (root@RTM3205:~)->
```

This last line is the standard RTM3205 prompt. After configuring the unit, you should change the passwords using the Linux `passwd` command issued from the prompt.

To gain `root` access, you must now issue the “super user” command at the prompt:

```
RTM3205 GPS(root@RTM3205:~)-> su root
```



You will then be prompted for the password, which is “endrun\_1”, and be granted *root* access to the system. To leave “super user” mode, issue the command **exit**. Issuing **exit** again will close the **telnet** session.

### Using SSH

When establishing a **ssh** connection with your RTM3205, logging in directly as *root* is permitted. When you log in as *root* via a **ssh** session with the RTM3205, this banner will be displayed:

```
*****  
*   Welcome to the RTM3205 GPS SSH console on:  host.your.domain  
*****  
  
root@M192.168.1.120's password:
```

Here you may log in as “root” with password “endrun\_1”. After correctly entering the password the sign on message is shown. It identifies the host system as RTM3205 and shows the software part number, version and build date:

```
RTM3205 GPS 6010-0069-000 v 1.00 Sat Jan 19 14:17:44 UTC 2013  
RTM3205 GPS (root@RTM3205:~)->
```

This last line is the standard RTM3205 prompt. After configuring the unit, you should change the passwords using the Linux **passwd** command issued from the prompt.

Issuing **exit** will close the **ssh** session.

### Using HTTPS

You may monitor the status of the RTM3205 via the HTTPS interface. For security reasons, you may not change any settings via the HTTPS interface. See *Chapter 4 - HTTPS* for more information.

#### IMPORTANT

SSH, Telnet, SNMP and HTTPS are all enabled with default passwords. To ensure security, change the passwords or disable the protocols.

To change the passwords for SSH, Telnet and HTTPS use the Linux **passwd** command. To change the passwords/community strings for SNMP see *Chapter 6 - SNMP*.

To disable Telnet, SSH, SNMP and HTTPS see *Chapter 5 - Security, Disable Protocols*.

## Connecting Instruments to the RTM3205

SMA jacks provide the means of connecting your equipment to the RTM3205. The RTM3205 can provide up to four optional outputs. Options are:

- Digital outputs (PPO, 1PPS, 10MPPS, DC time code, DDS)
- Amplitude-modulated (AM) time code
- Open-collector alarm
- 10 MHz low-phase-noise

The AM time code and the digital outputs are capable of driving properly terminated coaxial cables. These signals are DC-coupled and sourced from Advanced CMOS (ACMOS) drivers which are able to maintain output TTL levels into a 50-ohm load.

The low-phase noise, spectrally pure sine wave outputs are capable of driving 1 V<sub>rms</sub> into a 50-ohm load. Care should be taken not to short circuit these outputs or to connect them to other voltage sources.

If your unit is equipped with the optional Alarm Output, it will be available on an SMA jack labeled "ALARM". Care should be taken not to directly connect this open-collector output to a voltage source. A series current-limiting resistor of at least 1k ohms in value should be used. The pull-up voltage must not exceed 40V.

Refer to *Chapter 10 - Inputs/Outputs* and to *Appendix K - Specifications* for more information on the optional output signals.

# Chapter Three

## Console Port Control and Status

---

*This chapter describes RTM3205 control and status commands used via the Linux console. The console is accessed via any of the Ethernet ports or the RS-232 serial port. RTM3205 supports several application-specific commands for configuration and for monitoring the performance and status of the Linux and GPS Subsystems.*

*You do not need knowledge of Linux commands in order to operate RTM3205. However, RTM3205 does support a subset of the standard Linux commands and utilities and it uses the **bash** shell, which is the Linux standard, full-featured shell. A wealth of information is available from a variety of other sources on Linux.*

*RTM3205-specific commands will be described in this chapter. For a brief description of some of the most useful Unix/Linux commands, see **Appendix C - Helpful Linux Information**.*

### Console Ports

Three interface ports are available on RTM3205. Two are 10/100/1000Base-T Ethernet ports and one is an RS-232 serial port. Network cables and a serial cable are provided with each RTM3205 shipment. The serial cable is wired as a null-modem adapter and can be used to connect RTM3205 to the serial port on your computer. Detailed specifications on the ports, including the RS-232 pinout, are in *Appendix K - Specifications*.

### General Linux Operation

You do not need to know Linux in order to operate RTM3205. However, for those interested, the command shell used by RTM3205 is the Linux standard: **bash**. All commands and file names are case sensitive, which is standard for Unix-like operating systems. For a brief description of some of the most useful Unix/Linux commands, see *Appendix C - Helpful Linux Information*.

If you are unfamiliar with Unix-like operating systems, and you would like to be able to more closely monitor or optimize the performance of your RTM3205 then you should consult good Linux reference books or the Linux Documentation Project at:

<http://www.tldp.org>

## Available User Commands

COMMAND	FUNCTION
accessconfig	Interactive script that guides you in configuring <b>telnet</b> , <b>ssh</b> and <b>snmpd</b> access to RTM3205 that is limited to specific hosts. The resulting <i>/etc/hosts.allow</i> and <i>/etc/hosts.deny</i> files are saved to the non-volatile FLASH disk. Factory default configuration allows access by all hosts.
antfltmask	Prints the current setting for the Antenna Fault Mask. See the <b>setantfltmask</b> command.
caldelay	Prints the calibration delay. See the <b>setcaldelay</b> command.
clearalmanac	For use with a GPS simulator. See <i>Appendix J - Operation with a GPS Simulator</i> .
cpuio	Returns the current settings for any optional outputs such as the Programmable Pulse Output (PPO).
cpuioconfig	An interactive utility that allows you to modify the settings for any optional outputs, such as the Programmable Pulse Output (PPO).
cpustat	Prints the current Linux CPU core temperature, system load as percent of maximum and free memory available.
dumpalmanac	Prints the current GPS almanac data for all satellites in Yuma format.
dumpephemeris	Prints the last received GPS ephemeris data for all satellites in Rinex 3.01 format.
faultstat	Prints the summary of all system fault states in a user-friendly format.
get_sw_opts	Prints the software options enabled in your RTM3205. See <i>Appendix I - Software Options</i> for more information.
gpsdynmode	Prints the GPS dynamic mode currently in effect. See the <b>setgpsdynmode</b> command.
gpsionoinfo	Prints the GPS Ionospheric Model Almanac parameters per the IS-GPS-200.
gpslastfix	Prints the last computed GPS position fix.
gpsrefpos	Prints the GPS reference position. See the <b>setgpsrefpos</b> command.
gpsrefpos_ecef	Prints the GPS reference position in Earth-Centered Earth-Fixed format.
gpsstat	Prints the GPS Subsystem status information.
gpstrkstat	Prints the GPS satellite tracking status. Azimuth, elevation and signal level (C/No) are shown for each satellite.
gpsutcinfo	Prints the GPS UTC Almanac parameters per the IS-GPS-200. Also shows the current calculated GPS-UTC offset, which includes leap seconds and a small sub-second offset.
gpsversion	Prints the GPS Subsystem firmware and FPGA version information.

## CONTROL AND STATUS COMMANDS

help help command	Prints help for all RTM3205-specific (not Linux) commands. Prints command-specific help. For example: <b>help gpsstat</b> .
inetdconfig	Interactive script that allows you to configure the list of protocol servers which are started by the <b>inetd</b> server daemon running in RTM3205.
inhibitoutputsmode	Prints the current InhibitOutputsMode setting which controls the timing output signals (time codes and pulse rates) prior to initial lock to GPS. See the <b>setinhibitoutputsmode</b> command.
installed_sw_opts	Prints the software options enabled in your RTM3205. See <i>Appendix I - Software Options</i> for more information.
ionostat (optional)	Prints the status of the optional RTIC. See <i>Chapter 11 - Real-Time Ionospheric Corrections</i> for more information.
kernelversion	Prints the Linux operating system kernel version.
logrinex	Controls logging of raw GPS pseudorange and carrier phase observations in Rinex 2.11 format.
netconfig	Interactive script that allows you to configure the IP network subsystem of RTM3205.
ntpconfig	Interactive script that guides you in configuring the NTP Subsystem. Allows configuration of MD5 authentication and broadcast/multicast mode. All parameters are retained in non-volatile FLASH disk storage.
ntpstat	Prints the values of several key parameters indicating the status of the NTP daemon. These include the current offset between the NTP-steered system clock and the GPS Subsystem clock, and the current counts of received packets, sent packets and dropped packets. In addition the current sent packet rate is shown.
oscctrlstat	Prints the system oscillator disciplining parameters.
passwd	Used to change the password for the user that you are logged in as.
ptpconfig0 ptpconfig1 (optional)	Interactive script that guides you in configuring parameters for the optional PTP/IEEE-1588 protocol. See <i>Chapter 9 - PTP/IEEE-1588</i> for more information.
ptpstat0 ptpstat1 (optional)	Prints the status of the optional PTP/IEEE-1588 Subsystem. See <i>Chapter 9 - PTP/IEEE-1588</i> for more information.
rcvrserialnumber	Prints the serial number of the GPS Receiver.
rcvrstat	Prints the status of the GPS Receiver.
rcvrversion	Prints the GPS Receiver firmware and FPGA version information.
resetlastgpswn	For use with a GPS simulator. See <i>Appendix J - Operation with a GPS Simulator</i> .
resetleaphistory	For use with a GPS simulator. See <i>Appendix J - Operation with a GPS Simulator</i> .

rticmode (optional)	Prints the mode of the RTIC Option - either ON or OFF. See <i>Chapter 11 - Real-Time Ionospheric Corrections</i> for more information.
serialnumber	Prints the serial number of the RTM3205.
setantfltmask	Command to enable or mask the Antenna Fault. See the <b>antfltmask</b> command.
setcaldelay	An interactive utility that allows you to change the clock calibration delay. See the <b>caldelay</b> command.
setgpsdynmode	Command to set the dynamic mode of operation of the GPS Subsystem. See the <b>gpsdynmode</b> command.
setgpsrefpos	Interactive utility that prompts you for an accurate reference position, performs syntax and argument validity checking then passes the position to the GPS Subsystem. See the <b>gpsrefpos</b> command.
setinhibitoutputsmode	Sets the InhibitOutputsMode setting which controls the timing output signals (time codes and pulse rates) prior to initial lock to GPS. See the <b>inhibitoutputsmode</b> command.
setrticmode (optional)	Sets the RTIC mode - either ON or OFF. See <i>Chapter 11 - Real-Time Ionospheric Corrections</i> for more information.
setsigfltmask	Command to enable or mask the Signal Loss Fault. See the <b>sigfltmask</b> command.
settfomfltlvl	Command to change the TFOM fault level
sigfltmask	Prints the current setting for the Signal Loss Fault mask. See the <b>setsigfltmask</b> command.
subsysreset	Command that performs a GPS Subsystem reset.
syskernel	Prints the currently booted linux kernel, either 0 or 1, where 0 is the factory-installed kernel and 1 is the upgraded kernel.
sysosctype	Prints the installed system oscillator type, which is one of MS-OCXO, HS-OCXO or US-OCXO.
sysrootfs	Prints the currently loaded linux root file system image, either 0 or 1, where 0 is the factory-installed root file system, and 1 is the upgraded root file system.
sysstat	Prints detailed NTP status information. Included is the offset of the NTP-steered system clock to the GPS Subsystem clock, the NTP daemon leap indicator bit values, the TFOM, the time of the most recent update and the current leap seconds value.
systemio	Returns the current settings for installed system outputs such as 1 PPS and time code.
systemioconfig	An interactive utility that allows you to modify the settings for the system options.
systemimode	Prints the time mode settings in effect for the optional Time Code Output. See the <b>systemimodeconfig</b> command.

sysmemodeconfig	Interactive utility that guides you in configuring the time mode settings for the optional Time Code Output. Allows setting to the LOCAL, GPS or UTC timescale. See the <b>sysmemode</b> command.
sysversion	Prints the Linux root file system version information.
tfomftlvl	Prints the current setting for the TFOM Fault Level.
triggerppo (optional)	Starts execution of the Trigger PPO function. See <i>Chapter 10 - Inputs/Outputs (I/O), Programmable Pulse Output (PPO) Option</i> for more information.
updatekernelflag	Command to update the flag stored in FLASH that is read by the Linux bootloader at boot time to select operation with either the factory-installed or upgraded kernel.
updaterootflag	Command to update the flag stored in FLASH that is read by the Linux bootloader at boot time to select operation with either the factory-installed or upgraded root file system.
upgradekernel	Command that performs the Linux Kernel upgrade process.
upgradercvr	Command that performs the GPS Receiver upgrade process.
upgradercvrfpga	Command that upgrades the FPGA resident on the GPS Receiver.
upgraderootfs	Command that performs the Linux Root File System upgrade process.
upgradesubsys	Command that performs the GPS Subsystem firmware upgrade process.
wrt_sw_opt	Command to enable a software option. See <i>Appendix I - Software Options</i> for information.

## Detailed Command Descriptions

### accessconfig

This command starts an interactive script that will allow the root user to configure access limitation via **telnet**, **ssh** and **snmp** to RTM3205. By default, the unit is configured to allow access by all users. If you need to limit **telnet**, **ssh** or **snmp** access, e.g. for security reasons, you must run this script as root from either the RS-232 serial I/O port or from a **telnet** or **ssh** session.

This script modifies these files: */etc/hosts.allow* and */etc/hosts.deny*. These are non-volatilely stored in the FLASH disk */boot/etc* directory. You must reboot RTM3205 after running this script for the changes to take effect.

Command: **accessconfig**  
RTM3205 reply: Interactive script is started.

### antfltmask

This command displays the current setting for the Antenna Fault Mask.

Command: **antfltmask**  
RTM3205 reply: **Antenna Fault is ENABLED**

### **caldelay**

This command displays the current calibration delay setting for the GPS antenna cable. The allowable calibration delay range is  $\pm 500,000$  nanoseconds. See *Appendix E - Installing the GPS Antenna, Calibrate Your Receiver* for more details.

Command: **caldelay**  
RTM3205 reply: **+0 nanoseconds**

### **clearalmanac**

This command is for use with a GPS simulator. Refer to *Appendix J - Operation with a GPS Simulator* for more information.

### **cpuio**

This command displays the current settings for any optional outputs, such as the Programmable Pulse Output (PPO). See *Chapter 10 - Inputs/Outputs, Output Options* for more information.

Command: **cpuio**  
RTM3205 reply: **CPU I/O A - AM TIME CODE OUTPUT is Installed --  
Current Setting = (See systemio command)**  
  
**CPU I/O B - 1 PPS OUTPUT is Installed --  
Current Setting = (See systemio command)**  
  
**CPU I/O C - PROGRAMMABLE PULSE OUTPUT is Installed --  
Current Setting = 1M PPS**

### **cpuioconfig**

This command starts an interactive shell script that will allow the root user to change the settings of any installed, user-selectable, optional outputs. See *Chapter 10 - Inputs/Outputs, Programmable Pulse Output (PPO) Option* for more information.

Command: **cpuioconfig**  
RTM3205 reply: Interactive shell script is started.

### **cpustat**

This command shows a group of key values for monitoring the health of the Linux CPU and operating system status. The format is:

```
YYYYMMDD.HH:MM:SS LLL% FREEkB +TT.TC
```

Where:



---

## CONTROL AND STATUS COMMANDS

YYYY is the year of the UTC timestamp of the most recent update.

MMDD is the month and day-of-month of the UTC timestamp of the most recent update.

HH:MM:SS is the hour, minute and second of the UTC timestamp of the most recent update.

LLL% is the percentage of maximum load as returned using the Linux `vmstat` command.

FREEkB is the available free memory in kilobytes as returned using the Linux `vmstat` command.

+TT.TC is the temperature in degrees centigrade of the Linux CPU die temperature.

Command: `cpustat`

RTM3205 reply: `20130116.22:24:00 23% 320056kB +67.9C`

### **dumpalmanac**

This command prints the current GPS almanac data for all satellites in Yuma format.

Command: `dumpalmanac`

RTM3205 reply: Example shown below, for satellite 01

```
***** Week 1890 almanac for PRN-01 *****
ID:                01
Health:            000
Eccentricity:      5.217074882e-03
Time of Applicability(s): 5.038080000e+05
Orbital Inclination(rad): 9.637917876e-01
Rate of Right Ascen(r/s): -7.828898418e-09
SQRT(A) (m 1/2):   5.153603027e+03
Right Ascen at Week(rad): -1.158766985e+00
Argument of Perigee(rad): +4.515030086e-01
Mean Anom(rad):    -2.085680962e+00
Af0(s):            +1.621245974e-05
Af1(s/s):          +0.000000000e+00
week:              1.890000000e+03
```

### **dumpephemeris**

This command prints the current GPS ephemeris data for all satellites in Rinex 3.01 format.

Command: `dumpephemeris`

RTM3205 reply: Example shown below, for satellite 01

```
G01 2016 03 30 20 00 00 +1.58743932843e-05 +1.13686837722e-12 +0.00000000000e+00
+8.00000000000e+01 -1.13437500000e+01 +4.30446501253e-09 -2.12893752067e+00
-5.90458512306e-07 +5.20769448485e-03 +8.78982245922e-06 +5.15364822960e+03
+3.31200000000e+05 -1.26659870148e-07 -1.15738910133e+00 -5.58793544769e-09
+9.63788168503e-01 +2.12843750000e+02 +4.50864037440e-01 -7.82032574796e-09
+3.27513642258e-10 +1.00000000000e+00 +1.89000000000e+03 +0.00000000000e+00
+2.00000000000e+00 +0.00000000000e+00 +5.12227416039e-09 +8.00000000000e+01
+3.24258000000e+05 +4.00000000000e+00 +0.00000000000e+00 +0.00000000000e+00
```

### faultstat

This command returns the summary of all system and receiver fault states in a user-friendly format. An example is shown below. For details on the various faults see *Appendix G - System Faults*.

```

Command:      faultstat
RTM3205 reply: System Fault Status:
                System Oscillator DAC-----> OK
                GPS Signal-----> OK
                GPS Subsystem FPGA Configuration-----> OK
                GPS Subsystem FLASH Writes-----> OK
                GPS Receiver Communication-----> OK
                GPS Reference Time-----> OK
                Subsystem Communication-----> OK
                GPS Receiver-----> *FAULT*
                System Oscillator PLL-----> OK
                GPS Antenna-----> *FAULT*

                GPS Receiver Fault Status:
                GPS Receiver Oscillator DAC-----> OK
                GPS Signal-----> OK
                GPS Receiver FPGA Configuration-----> OK
                GPS Receiver FLASH Writes-----> OK
                Local Oscillator Synthesizer Tuning-----> OK
                Local Oscillator Synthesizer-----> OK
                GPS Reference Time-----> OK
                GPS Receiver Oscillator-----> OK
                GPS Antenna Short-----> OK
                GPS Antenna Open-----> *FAULT*
                GPS Receiver Oscillator PLL-----> OK

```

### get\_sw\_opts

See *Appendix I - Software Options* for information on this command.

### gpsdynmode

This command displays the current GPS Subsystem dynamic mode of operation. It has two possible settings: OFF or ON. When it is OFF, it is assumed that RTM3205 is installed in a stationary location. When it is ON, it is assumed that RTM3205 is installed on a moving platform. Dynamic mode is intended for shipboard applications only.

When the dynamic mode is OFF, RTM3205 will use its accurate reference position to implement Timing Receiver Autonomous Integrity Monitoring (TRAIM) for the utmost in reliability during any GPS system faults. In addition, single satellite operation is possible once an initial accurate position has been determined.

When the dynamic mode is ON, only a very minimal TRAIM algorithm is in effect because the accurate reference position is not static. In addition, a minimum of four satellites must be visible and only 3-D position fixes are used. When the dynamic mode is ON, the source reported for the accurate reference position by **gpsrefpos** is set to DYN. Dynamic mode is intended for shipboard applications only.

Command: **gpsdynmode**  
RTM3205 reply: **OFF**

### **gpsionoinfo**

This command provides the current and previously received GPS ionospheric model coefficients. Also shown are the week number and time-of-week of the almanac transmissions that contained the two sets of model coefficients.

Command: **gpsionoinfo**  
RTM3205 reply:

**GPS Ionosphere Model Almanac Parameters:**

```
WN_a = 1890 T_oa = 503808
Alpha0 = +1.676e-08 Alpha1 = +7.451e-09 Alpha2 = -1.192e-07 Alpha3 = -5.960e-08
Beta0 = +1.106e+05 Beta1 = +1.638e+04 Beta2 = -2.621e+05 Beta3 = -6.554e+04
WN_a = 1890 T_oa = 405504
Alpha0 = +1.676e-08 Alpha1 = +7.451e-09 Alpha2 = -1.192e-07 Alpha3 = -5.960e-08
Beta0 = +1.106e+05 Beta1 = +1.638e+04 Beta2 = -2.621e+05 Beta3 = -6.554e+04
```

### **gpslastfix**

This command provides the last computed GPS position. When tracking four or more satellites, the GPS Receiver may provide a 3D-position fix, otherwise an overdetermined time-only solution will be computed. The last-fix position is unaveraged and typically less accurate than the reference position, but it does provide a good indication that the receiver is working properly. Position is provided in latitude, longitude and height above the WGS-84 ellipsoid. PDOP, HDOP, VDOP and TDOP are also shown. OORCnt is the out-of-range counter which may be non-zero when RTM3205 has been moved more than 1 km from its previous location without being placed in UNKNOWN mode using the **setgpsrefpos** command. It could also be non-zero during a GPS system anomaly, in which case RTM3205 TRAIM algorithms will be operating to maintain the integrity of the system timing.

Command: **gpslastfix**  
RTM3205 reply: **LAST POSITION FIX = N38d24m54.33s W122d45m10.99s +00003.5 meters**  
**PDOP: 2.90 HDOP: 1.48 VDOP: 2.49 TDOP: 2.03 OORCnt: 0**

### **gpsrefpos**

This command displays the current GPS Subsystem reference position. The source of the position, which is one of UNK (unknown), DYN (dynamic), USR (user entered) or AVG (24 hour average of GPS fixes) is displayed first. The WGS-84 latitude and longitude in degrees, minutes, seconds format and the height above the WGS-84 reference ellipsoid in meters follow. Also, the current RMS PDOP of the average position and the current count of averages are shown. If the reference position source is not AVG, then these two values will be zero.

Command: **gpsrefpos**  
RTM3205 reply:  
**CURRENT REFERENCE POSITION = AVG N38d24m54.30s W122d45m10.95s +00004.1 meters**  
**RMSPDOP: 2.4 AvgCnt: 28800**

### **gpsrefpos\_ecef**

This command displays the current GPS Subsystem reference position in Earth-Centered Earth-Fixed

format. The source of the position, which is one of UNK (unknown), DYN (dynamic), USR (user entered) or AVG (24 hour average of GPS fixes) is displayed first. The WGS-84 X, Y, Z coordinates in meters are displayed next. Then, the current RMS PDOP of the average position and the current count of averages are shown. If the reference position source is not AVG, then these two values will be zero.

```
Command:      gpsrefpos_ecef
RTM3205 reply:
CURRENT REFERENCE POSITION ECEF = AVG X: -2707225.0 m Y: -4208361.2 m Z: +3941650.2 m
RMSPDOP: 2.4 AvgCnt: 28800
```

### **gpsstat**

This command allows you to query the status of the GPS Subsystem. During normal operation, the system polls the GPS Subsystem every 10 seconds. The results of this poll are used to steer the system clock and are saved to a log file. This command parses and formats the data contained therein and prints this fixed-length string having these fields:

```
LKSTAT TFOM = ? YEAR DOY HH:MM:SS LS LF S NN AGC EFCDAC C/No FLTR FLTS
```

Where:

LKSTAT is the tracking status of the GPS Subsystem, either LOCKED or NOTLKD.

TFOM = ? is a value between 3 and 9 and indicates clock accuracy.

A detailed explanation of TFOM is in *Appendix A - TFOM*.

YEAR is the year of the UTC timestamp of the most recent update.

DOY is the day-of-year of the UTC timestamp of the most recent update.

HH:MM:SS is the hour, minute and second of the UTC timestamp of the most recent update.

LS is the current number of leap seconds difference between the UTC and GPS timescales (18 at the time of this writing).

LF is the future (at the next UTC midnight) number of leap seconds difference between the UTC and GPS timescales (18 at the time of this writing).

S is the Signal Processor State, one of 0 (Acquiring), 1 (GPS Locking), 2 (GPS Locked), 9 (Warming Up).

NN is the number of GPS satellites being tracked, 0 to 12.

AGC is the RF front-end Automatic Gain Control 8-bit DAC value. Typical range is 125 to 200, with larger numbers implying higher gain being used.

EFCDAC is the system oscillator Electronic Frequency Control 20-bit DAC value, 0 to 1048575 with larger numbers implying higher oscillator frequency. Typical range is 320000 to 680000.

## CONTROL AND STATUS COMMANDS

C/No is the received GPS Carrier Signal-to-Noise Ratio, 0.00 to 99.9, measured in dB in a 1Hz bandwidth. Typical range is 39 to 50.

FLTR is the fault status for the GPS Receiver. This is a numeric value consisting of four hexadecimal characters where each bit indicates a particular receiver fault. Assertion of any of these bits will light the Alarm LED. Bit definitions are shown below, Decoding the bits can be difficult for non-programmers. For a more user-friendly method of reading the fault status use the **faultstat** command. For details on each system fault see *Appendix G - System Faults*.

	Bit 3	Bit 2	Bit 1	Bit 0
Char 0	GPS Rcvr FLASH Writes	GPS Rcvr FPGA Config	GPS Signal	GPS Rcvr Oscillator DAC
Char 1	GPS Rcvr Oscillator	GPS Reference Time	Synthesizer	Synthesizer Limits
Char 2	N/A	Rcvr Osc PLL	Antenna Open	Antenna Short
Char 3	N/A	N/A	N/A	N/A

FLTS is the fault status for the GPS Subsystem. This is a numeric value consisting of four hexadecimal characters where each bit indicates a particular system fault. Assertion of any of these bits will light the Alarm LED. Bit definitions are shown below. Decoding the bits can be difficult for non-programmers. For a more user-friendly method of reading the fault status use the **faultstat** command. For details on each system fault see *Appendix G - System Faults*.

	Bit 3	Bit 2	Bit 1	Bit 0
Char 0	FLASH Writes	FPGA Configuration	GPS Signal	System Oscillator DAC
Char 1	GPS Receiver	Subsystem Communication	GPS Reference Time	GPS Receiver Communication
Char 2	GPS Antenna	System Osc PLL	N/A	N/A
Char 3	N/A	N/A	N/A	N/A

The example reply below indicates that there has been a period without tracking a GPS signal that exceeded the time-out period, that there was a FLASH Write Fault and that there is an Antenna Fault.

Command: **gpsstat**

RTM3205 reply:

**LOCKED TFOM = 4 2001 092 04:48:56 13 13 2 7 151 328605 41.6 0200 0880**

### **gpstrkstat**

This command displays the current GPS Subsystem satellite tracking status. A list of twelve satellite numbers along with azimuth, elevation and C/No is displayed for each receiver channel. Satellite number 0 is an invalid number and indicates that no satellite is being tracked on that channel. Valid satellite numbers range from 1 to 32. Azimuth and elevation are in degrees and C/No is in dB.

```

Command:      gpstrkstat
RTM3205 reply: Ch SV Azimuth   Elev C/No
                1 23 -108.41 +15.70 41.7
                2 11 -118.21 +45.58 46.9
                3 22 +107.41 +21.04 37.9
                4 14 +52.10 +29.76 40.4
                5 32 -40.36 +58.18 45.2
                6  1 -79.14 +55.53 46.6
                7 31 +127.87 +62.60 47.3
                8  0 +0.00 +0.00  0.0
                9  0 +0.00 +0.00  0.0
               10  0 +0.00 +0.00  0.0
               11  0 +0.00 +0.00  0.0
               12  0 +0.00 +0.00  0.0

```

### gpsutcinfo

This command displays the IS-GPS-200 almanac parameters which are used to relate GPS time to UTC. The first line of output contains the current (LS) and future (LSF) leap second values and the GPS week number (WN\_lsf) and day of week (DN) at the end of which the future leap second will take effect. This could be in the past if a leap second insertion has recently taken place. Leap second events typically occur every one-and-a-half to three years on either June 30 or December 31.

The second line of output contains the parameters for calculating the small residual offset between the GPS master clock ensemble and UTC(USNO). This is typically less than 10 nanoseconds. The remaining output shows the current value of the GPS-UTC offset.

```

Command:      gpsutcinfo
RTM3205 reply: GPS UTC Almanac Parameters:
                LS = 18  LSF = 18  WN_lsf = 1694  DN = 7
                a0 = +9.313226e-10  a1 = -1.243450e-14  WN_t = 1727  t_ot = 61440
                Current (GPS - UTC) Offset:
                GPS - UTC = (18 + 3.810e-09) s @ WN = 1726, TOW = 434757

```

### gpsversion

This command displays the firmware and hardware versions of the GPS Subsystem.

```

Command:      gpsversion
RTM3205 reply:
                F/W 6010-0076-000 Ver 1.00 - FPGA 6020-0016-000 Ver 01 - JUL 15 17:03:27 2015

```

### help

This command displays a list of RTM3205 commands (not Linux commands). To get help on a particular command you would type **help**, followed by the command.

```

Command:      help
RTM3205 reply: RTM3205 commands are displayed.
Command:      help gpsstat
RTM3205 reply: Information specific to the gpsstat command is displayed.

```

### **inetdconfig**

This command starts an interactive script that allows you to configure the list of protocol servers which are started by the **inetd** super-server daemon running in RTM3205. Three protocol servers may be configured: Time, Daytime, and Telnet. By default, the unit is configured to start all of these protocol servers. If you need to disable start-up of some or all of these, e.g. for security reasons, you must run this script as *root* from either the RS-232 serial I/O port or from a **telnet** or **ssh** session.

This script modifies the */etc/inetd.conf* file, which is non-volatilely stored in the FLASH disk */boot/etc* directory. You must reboot RTM3205 after running this script for the changes to take effect.

Command: **inetdconfig**  
RTM3205 reply: Interactive script is started.

### **inhibitoutputsmode**

This command shows the current inhibit mode of the timing signal outputs (if any) prior to initial system lock to the GPS receiver. If it is set to ON, then all timing signals will be inhibited (not present) until the system is locked to the timing receiver. If it is set to OFF, then the timing signals will be present at all times.

Command: **inhibitoutputsmode**  
RTM3205 reply: **OFF**

### **installed\_sw\_opts**

See *Appendix I - Software Options* for information on this command.

### **ionostat (Optional)**

This command is only available if the RTIC option has been installed. Refer to *Chapter 11 - Real-Time Ionospheric Corrections* for more information.

### **kernelversion**

This command prints the current Linux operating system kernel firmware version.

Command: **kernelversion**  
RTM3205 reply:  
**6010-0064-000\_v1.00 Linux Kernel 3.2.2-Sonoma #2 Dec 19 01:08:43 2012**

### **logrinex**

This command is used to control logging of raw GPS pseudorange and carrier phase observations in the Rinex version 2.11 format to the */home/rinex/rinex.log* file. It requires one argument, which may be either ON or OFF.

If ON is asserted and logging is not currently in progress, then a new log of 2880 observations taken every 30 seconds will begin. Assuming full constellation visibility, this will take 24 hours to complete. If a previously-initiated log is in progress, then an ON assertion will be ignored.

IMPORTANT!!! The data is always appended to the `/home/rinex/rinex.log` file, so if you are performing multiple logs, it is up to you to manage the file and remove it before it grows too large and fills the limited storage available.

If OFF is asserted, then any currently active log will be terminated. Data logged prior to the OFF assertion is not discarded.

Once a complete log is available, you will need to prepend the Rinex version 2.11 header to it. An example header is contained in a file in the same directory with the log file for reference:

```
/home/rinex/rinex_header_2.11
```

You will need to edit various fields in it for your requirements. When you have a complete log with header, you may submit it to the Natural Resources Canada website for Precise Point Position (PPP) processing using the CSRS-PPP tool. This is the only freely-accessible PPP tool that will perform single-frequency PPP processing that we are aware of. The web URL is :

<http://www.nrcan.gc.ca/earth-sciences/geomatics/geodetic-reference-systems/tools-applications/10925#ppp>

```
Command:      logrinex ON  
RTM3205 reply: Rinex Log Control Command Successful
```

### **netconfig**

This command starts an interactive script that allows you to configure the IP network subsystem of RTM3205. By default, the unit is configured to configure itself using the Dynamic Host Configuration Protocol (DHCP). If you need to set up static IP configuration, you must run this script as *root* from the RS-232 serial I/O port during the installation process. Refer to **Chapter 2 - Basic Installation, Using netconfig to Set Up Your IP** for details on the use of the command.

This script creates or modifies these files: `/etc/HOSTNAME`, `/etc/hosts`, `/etc/networks`, `/etc/resolv.conf` and `/etc/rc.d/rc.inet1.conf`. All of these are non-volatilely stored in the FLASH disk `/boot/etc` directory. You must reboot RTM3205 after running this script for the changes to take effect.

```
Command:      netconfig  
RTM3205 reply: Interactive script is started.
```

### **ntpconfig**

This command starts an interactive script that allows you to configure the NTP Subsystem of RTM3205. By default, the unit is configured to authenticate its replies to clients using its default MD5 keys in the `/etc/ntp.keys` file. If you need to create your own MD5 keys (recommended) or set up broadcast/multicast operation, you must run this script as *root*. Refer to **Chapter 7 - Configuring the NTP Server** for details on the use of this command.

The two files that are modified are `/etc/ntp.keys` and `/etc/ntp.conf`. Both of these are non-volatilely stored in the FLASH disk `/boot/etc` directory. You must reboot RTM3205 after running this script for the changes to take effect.



Command: **ntpconfig**  
RTM3205 reply: Interactive script is started.

### **ntpstat**

This command provides some key information regarding the operation of the NTP daemon. It shows the current offset between the NTP-steered system clock and the GPS Subsystem, the counts of received, sent and dropped packets, and the sent packet rate. The format of the response is:

**YYYYMMDD.HH:MM:SS +S.ssssssss RCVDCNT SENTCNT SENT/sec DROPCNT**

Where:

**YYYY** is the year of the UTC timestamp of the most recent update received from the GPS Subsystem.

**MMDD** is the month and day-of-month of the UTC timestamp of the most recent update received from the GPS Subsystem.

**HH:MM:SS** is the hour, minute and second of the UTC timestamp of the most recent update received from the GPS Subsystem.

**+S.ssssssss** is the offset in seconds between the NTP system clock and the GPS Subsystem clock. Positive implies that the system clock is ahead of the GPS Subsystem clock.

**RCVDCNT** is a count of the number of NTP packets received since startup of the NTP daemon. This is a 32-bit counter so it will wrap back to zero after 4,294,967,295 packets.

**SENTCNT** is a count of the number of NTP packets sent since startup of the NTP daemon. This is a 32-bit counter so it will wrap back to zero after 4,294,967,295 packets.

**SENT/sec** is the current rate of NTP packets being sent per second.

**DROPCNT** is a count of the number of NTP packets dropped since startup of the NTP daemon. This is a 32-bit counter so it will wrap back to zero after 4,294,967,295 packets.

Below is an example of a typical response to this command:

Command: **ntpstat**  
RTM3205 reply:  
**20130117.00:02:40 -0.000000051 129127988 129015079 1594.4/sec 15**

### **oscctrlstat**

This command displays the current values of the system oscillator control parameters. These parameters are related to the disciplined system oscillator. The command formats the data and prints this fixed-length string having these fields:

**YYYYMMDD.HH:MM:SS LKSTAT COAST ESTERR MEASERR TIMEDEV AGERATE TAU EFCDAC TEMP**

Where:

YYYY	is the year of the UTC timestamp of the most recent update received from the GPS Subsystem.
MMDD	is the month and day-of-month of the UTC timestamp of the most recent update received from the GPS Subsystem.
HH:MM:SS	is the hour, minute and second of the UTC timestamp of the most recent update received from the GPS Subsystem.
LKSTAT	is the GPS Subsystem control status, either WRM (warming up), ACQ (acquiring), LKG (locking) or LKD (locked).
COAST	is the number of seconds the GPS Subsystem has been in coast mode (unlocked to GPS).
ESTERR	is the estimated time error of the GPS Subsystem when in coast mode, in seconds.
MEASERR	is the last measured time offset of the GPS Subsystem to GPS while locked, in seconds.
TIMEDEV	is the time deviation (TDEV) of the offset measurements in seconds. The tau associated with this measurement is three seconds, which is the update interval of the position fixes received from the GPS Receiver.
AGERATE	is the regression-computed system oscillator ageing rate per day (several-hour delay before the first measurements are displayed).
TAU	is the system oscillator control loop averaging time constant, in seconds. It's value is automatically adjusted to maintain optimum offset and stability.
EFCDAC	is the system oscillator Electronic Frequency Control 20-bit DAC value. The system automatically sets this value to remove frequency errors. Values may range from 0 to 1048575. Values close to the maximum or minimum will set the DAC fault flag that will appear in the fault status display. The Time/Status display will also indicate a fault condition.
TEMP	is the chassis internal temperature in °C.

Below is an example of a typical response to this command:

```
Command:    oscctrlstat
RTM3205 reply:
20130117.00:23:10 LKD      0 6.26e-09 -6.26000e-09 1.25e-09 -6.93e-13 1955.3 524281
+50.750
```

**passwd**

This command is used to change the password for the user that you are logged in as. It affects the serial port, SSH, Telnet and HTTPS. **passwd** is a Linux command that is also described in *Appendix C - Helpful Linux Information*.

Command: **passwd**  
RTM3205 reply: Interactive script is started.

**ptpconfig0 and ptpconfig1 (Optional)**

These commands are only available if the Precision Time Protocol (PTP) option has been installed. Refer to *Chapter 9 - PTP/IEEE-1588* for more information.

**ptpstat0 and ptpstat1 (Optional)**

These commands are only available if the Precision Time Protocol (PTP) option has been installed. Refer to *Chapter 9 - PTP/IEEE-1588* for more information.

**rcvrserialnumber**

This command shows the serial number of the GPS receiver in the RTM3205.

Command: **rcvrserialnumber**  
RTM3205 reply: **15080056**

**rcvrstat**

This command shows three critical status parameters of the GPS Receiver: the number of satellites currently being tracked, the automatic gain control DAC value for the receiver front end, and the average Carrier-to-Noise ratio of the tracked satellites.

Command: **rcvrstat**  
RTM3205 reply: **20150622.23:35:50 8 125 45.0**

**rcvrversion**

This command displays the firmware and hardware versions of the GPS Subsystem.

Command: **rcvrversion**  
RTM3205 reply:  
**F/W 6010-0081-000 Ver 1.00 - FPGA 6020-0014-000 Ver 01 - MAR 24 15:05:36 2015**

**resetlastgpswn**

This command is for use with a GPS simulator. Refer to *Appendix J - Operation with a GPS Simulator* for more information.

**resetleaphistory**

This command is for use with a GPS simulator. Refer to *Appendix J - Operation with a GPS Simulator* for more information.

**rticmode (Optional)**

This command is only available if the RTIC option has been installed. Refer to *Chapter 11 - Real-Time Ionospheric Corrections* for more information.

**serialnumber**

This command shows the serial number of the RTM3205.

```
Command:      serialnumber  
RTM3205 reply: 15080056
```

**setantfltmask**

This command allows you to enable or mask the GPS antenna fault. Parameter for this command is either MASKED or ENABLED. Setting this command to MASKED will prevent the antenna fault from creating an alarm condition. Some installations may need to mask this fault due to special antenna situations like splitters or DC blocks that confuse the antenna detection circuit. The factory default setting is ENABLED.

```
Command:      setantfltmask MASKED  
RTM3205 reply: Antenna Fault Mask set to MASKED
```

**setcaldelay**

This command starts an interactive utility that allows you to change the clock calibration delay. This setting is used to advance or retard the clock in order to compensate for antenna cable length or other external hardware or cabling. See *Appendix E - Installing the GPS Antenna, Calibrate Your Receiver* for more details.

```
Command:      setcaldelay  
RTM3205 reply: Interactive utility is started.
```

**setgpsdynmode**

This command accepts a single argument: ON or OFF, to allow you to set the dynamic mode of operation of the GPS Subsystem. By default, the unit is configured for static operation, so this setting is OFF. It is important that the dynamic mode be set OFF when the instrument is in a static installation.

If RTM3205 will be mounted on a moving platform then this setting must be changed to ON. The change takes place immediately and is stored non-volatilely. Dynamic mode is intended for ship-board applications only.

```
Command:      setgpsdynmode ON  
RTM3205 reply: GPS Dynamic Mode is ON
```

### **setgpsrefpos**

This command starts an interactive utility that allows you to set the accurate reference position of RTM3205. This utility must be run as the root user. By default, the unit is configured to locate itself using the GPS satellites. In some situations, visibility of the sky is limited and RTM3205 will not be able to determine its position. In this case, you must determine an accurate WGS-84 position by other means and input it using this command. Changes you make to the position take place immediately. Refer to *Appendix E - Installing the GPS Antenna, GPS Reference Position* for details. *If the GPS dynamic mode setting is ON (see `gpsdynmode/setgpsdynmode` commands), then running this utility will have no effect.*

In addition to setting a new reference position, you can also invalidate an existing one. We recommend you do this if RTM3205 has an established position and then you move your GPS antenna. You can invalidate an old position by setting the position mode to UNKNOWN. This will speed up the time it takes for RTM3205 to acquire a new position and relock to the GPS signal. A cold start in unknown position mode should take about 20 minutes to lock, assuming a decent antenna installation.

Command: **setgpsrefpos**  
RTM3205 reply: Interactive utility is started.

### **setinhibitoutputsmode**

This command allows you to set the inhibit mode of the timing outputs. Timing outputs are pulse rates and time codes. If it is set to ON, then all timing outputs will be inhibited (not present) until the system is locked to the GPS signal. If it is set to OFF, then all timing outputs will be present at all times. This command requires one argument: ON or OFF.

Command: **setinhibitoutputsmode ON**  
RTM3205 reply: **Inhibit Outputs Mode is ON**

### **setrticmode (Optional)**

This command is only available if the RTIC option has been installed. Refer to *Chapter 11 - Real-Time Ionospheric Corrections* for more information.

### **setsigfltmask**

This command allows you to enable or mask the Signal Loss Fault. Parameter for this command is either MASKED or ENABLED. Setting this command to MASKED will prevent a signal loss fault from creating an alarm condition. Some installations may need to mask this fault when operating the NTP server as a Stratum 2 server. The factory default setting is ENABLED.

Command: **setsigfltmask MASKED**  
RTM3205 reply: **Signal Loss Fault Mask set to MASKED**

### **settfomfltlvl**

This command allows you to change the TFOM Fault Level. This is the threshold at which a signal loss fault will be asserted. See *Appendix A - Time Figure of Merit* for more information. By changing the TFOM Fault Level you control the point at which the time error will produce a signal loss

fault, which then creates an alarm condition. The factory default setting is 9, which is the maximum TFOM value.

```
Command:      settfomfltlvl 6
RTM3205 reply: TFOM Fault Level set to 6
```

### **sigfltmask**

This command displays the current setting for the Signal Loss Fault Mask.

```
Command:      sigfltmask
RTM3205 reply: Signal Loss Fault is ENABLED
```

### **subsysreset**

This command performs a GPS Subsystem reset which is similar to cycling the power on the GPS Subsystem. After about 10 seconds, the boot messages from the GPS Subsystem will be displayed.

```
Command:      subsysreset
RTM3205 reply:
Bootloader 6010-0070-000 v 1.00 - Dec 27 2012 14:48:55
FW 6010-0076-000 v 1.00 - Jul 12 2015 16:08:46
FPGA 6020-0016-000 v 01
Wait 13 seconds while resetting GPS receiver...
```

### **syskernel**

This command returns the currently booted linux kernel, either 0 or 1, where 0 is the factory-installed kernel and 1 is the upgraded kernel.

```
Command:      syskernel
RTM3205 reply: BOOTED KERNEL IMAGE = 1 (Upgrade)
```

### **sysosctype**

This command displays the installed system oscillator type. It is either MS-OCXO, HS-OCXO or US-OCXO.

```
Command:      sysosctype
RTM3205 reply: Installed Oscillator is MS-OCXO.
```

### **sysrootfs**

This command returns the currently loaded linux root file system, either 0 or 1, where 0 is the factory-installed root file system and 1 is the upgraded root file system.

```
Command:      sysrootfs
RTM3205 reply: BOOTED ROOT FILE SYSTEM IMAGE = 1 (Upgrade)
```

**sysstat**

This command allows you to query the status of the NTP Subsystem. It retrieves information from the NTP daemon to determine the current synchronization status of the NTP Subsystem. It then retrieves the last line in the logfile `/var/log/praecis0.monitor` controlled by the NTP daemon reference clock driver that communicates with the GPS Subsystem. This logfile is updated every 16 seconds under normal operation. It parses and formats the data contained therein and prints this fixed-length (generally, since grossly unsynchronized states could cause the floating offset field to overflow momentarily) string having these fields:

```
LKSTAT TO GPS, Offset = +S.ssssssss, LI = ??, TFOM = ? @ YEAR DOY HH:MM:SS LS
```

Where:

**LKSTAT** is the system peer status of the NTP daemon relative to the GPS Subsystem, either **LOCKED** or **NOTLKD**. **NOTLKD** can imply several things: the system has just started, there is a fault in the GPS Subsystem which has caused NTP to either be unable to obtain timing information from the GPS Subsystem or to reject the timing information that it is obtaining from it.

**+S.ssssssss** is the offset in seconds between the NTP system clock and the GPS Subsystem clock. Positive implies that the system clock is ahead of the GPS Subsystem.

**LI = ??** is the NTP daemon leap indicator bits. Leap seconds typically occur every 1 - 3 years. Possible indicator values are:

00:	Normal, locked operation.
01:	Leap second insertion event will occur after 23:59:59 UTC.
11:	Fault. Unsynchronized state.

**TFOM = ?** is a value between 3 and 9 and indicates clock accuracy. A detailed explanation of TFOM is in *Appendix A - TFOM*.

**YEAR** is the year of the UTC timestamp of the most recent update received from the GPS Subsystem.

**DOY** is the day-of-year of the UTC timestamp of the most recent update received from the GPS Subsystem.

**HH:MM:SS** is the hour, minute and second of the UTC timestamp of the most recent update received from the GPS Subsystem.

**LS** is the current number of leap seconds difference between the UTC and GPS timescales (18 at the time of this writing).

Below is an example of a typical response to this command:

```
Command:      sysstat
RTM3205 reply:
LOCKED TO GPS, Offset = +0.000000024, LI = 00, TFOM = 4 @ 2013 012 06:03:10 18
```

**systemio**

This command returns the current settings for all installed, system-wide I/O signals that may be routed to the SMA connectors. These signals are the 1 PPS, Time Code and Direct Digital Synthesizer (DDS) outputs. See *Chapter 10 - Inputs/Outputs* for information on the various options.

```
Command:      systemio
RTM3205 reply: System I/O Signal 1 PPS OUTPUT is Installed --
                Current Setting = 1 Milliseconds Pulse Width

                System I/O Signal TIME CODE OUTPUT is Installed --
                Current Setting = IRIG-B122/B002 Format
```

**systemioconfig**

This command is an interactive utility that allows the root user to modify the settings for all installed, system-wide I/O signals. See *Chapter 10 - Inputs/Outputs* for information on the various options and modules.

```
Command:      systemioconfig
RTM3205 reply: Interactive shell script is started.
```

**systemmode**

This command displays the current time mode for the optional Time Code Output. Time modes are UTC, GPS and LOCAL. The displayed Local Time Offset from UTC and the DST Start/Stop parameters are only valid when the time mode is LOCAL. A positive Local Time Offset implies a longitude east of the Greenwich meridian and that Local time is ahead of UTC.

```
Command:      systemmode
RTM3205 reply:
Time Mode = LOCAL
Local Time Zone Offset from UTC (Does Not Include DST) = -16 (half hours)
DST Start Month = Mar Sunday = 2nd Hour = 2
DST Stop Month = Nov Sunday = 1st Hour = 2
```

**systemmodeconfig**

This command starts an interactive utility that allows you to configure the time mode of the optional Time Code Output. *These settings have no effect on the operation of the NTP daemon or the underlying Linux operating system time. These ALWAYS operate in UTC.*

By default, the unit is configured to operate in UTC mode. If you need to modify the setting, you must run this utility as root. Settings made using this command are non-volatile.

```
Command:      systemmodeconfig
RTM3205 reply: Interactive utility is started.
```



**sysversion**

This command displays the firmware version and build date of the Linux root file system.

```
Command:      sysversion
RTM3205 reply: RTM3205 GPS 6010-0069-000 v 1.00 - Jan 16 22:38:21 2013
```

**tfomfltlvl**

This command displays the current setting for the TFOM fault level.

```
Command:      tfomfltlvl
RTM3205 reply: TFOM fault level set to 6
```

**triggerppo (Optional)**

This command is only available if one or more Programmable Pulse Output (PPO) options have been installed. Refer to *Chapter 10 - Inputs/Outputs (I/O), Programmable Pulse Output (PPO) Option* for more information.

**updatekernelflag**

This command allows you to update the configuration of the Linux bootloader after a new kernel image has been written to the UPGRADE kernel partition of RTM3205 FLASH disk. You may also use it to reset the default back to the FACTORY kernel partition. Refer to *Appendix B - Upgrading the Firmware, Performing the Linux Kernel Upgrade* for detailed instructions for performing the upgrade procedure. One argument is accepted, whose value is either 0 or 1, which causes a flag to be set that indicates to the bootloader which kernel image should be loaded by default. If an argument value of 2 is given, then the currently configured default kernel is shown.

```
Command:      updatekernelflag 1
RTM3205 reply: Default Kernel now set to: UPGRADE
Command:      updatekernelflag 2
RTM3205 reply: Default Kernel = UPGRADE
```

**updaterootflag**

This command allows you to update the configuration of the Linux bootloader after a new root file system image has been written to the UPGRADE root file system partition of RTM3205 FLASH disk. You may also use it to reset the default back to the FACTORY root file system partition. Refer to *Appendix B - Upgrading the Firmware* for detailed instructions for performing the upgrade procedure. One argument is accepted, whose value is either 0 or 1, which causes a flag to be set that indicates to the bootloader which root file system image should be loaded by default. If an argument value of 2 is given, then the currently configured default root file system is shown.

```
Command:      updaterootflag 1
RTM3205 reply: Default Root File System now set to: UPGRADE
Command:      updaterootflag 2
RTM3205 reply: Default Root File System = UPGRADE
```

**upgradkernel**

This utility allows you to upgrade the Linux Kernel. It is run after the *kernel.gz* file has been copied to the */tmp* directory on the system. It performs an erase of the upgrade kernel partition and then writes the */tmp/kernel.gz* file to it. Refer to *Appendix B - Upgrading the Firmware, Performing the Linux Kernel Upgrade* for detailed information.

Command: **upgradkernel**  
RTM3205 reply: Shows progress indicator.

**upgradercvr**

This utility allows you to upgrade the GPS Receiver firmware. Prior to executing this command, you must copy the new binary firmware file to */tmp/rcvr.bin*.

The utility starts the X-modem file transfer, and then displays progress to the console. See *Appendix B - Upgrading the Firmware, Performing the GPS Receiver Upgrade* for more information.

Command: **upgradercvr**  
RTM3205 reply: Upgrade progress is shown.

**upgradercvrfpga**

This utility allows you to upgrade the Field-Programmable Gate Array (FPGA) resident on the GPS Receiver. Prior to executing this command, you must copy the new binary file to */tmp/rcvrfpga.bin*.

The utility starts the X-modem file transfer, and then displays progress to the console. See *Appendix B - Upgrading the Firmware, Performing the GPS Receiver FPGA Upgrade* for more information.

Command: **upgradercvrfpga**  
MeridianII reply: Upgrade progress is shown.

**upgraderootfs**

This utility allows you to upgrade the Linux Root File System. It is run after the *rootfs.gz* file has been copied to the */tmp* directory on the system. It performs an erase of the upgrade root file system partition and then writes the */tmp/rootfs.gz* file to it. Refer to *Appendix B - Upgrading the Firmware, Performing the Linux RFS Upgrade* for detailed information..

Command: **upgraderootfs**  
RTM3205 reply: Shows progress indicator.

**upgradesubsys**

This utility allows you to upgrade the GPS Subsystem firmware. Prior to executing this command, you must copy the binary firmware file to be uploaded to the GPS Subsystem to */tmp/subsys.bin*.

It issues the commands over the serial port to the GPS Subsystem that are needed to start the X-modem file transfer, and then displays progress to the console. See *Appendix B - Upgrading the Firmware, Performing the GPS Subsystem Upgrade* for more information.

Command: **upgradesubsys**  
RTM3205 reply: Upgrade progress is shown.

**wrt\_sw\_opt**

See *Appendix I - Software Options* for information on this command.

This page intentionally left blank.

# Chapter *Four*

## *Hyper Text Transfer Protocol Secure (HTTPS)*

*This chapter briefly describes the HTTPS interface that resides on the RTM3205 Precision Timing Module. The HTTPS interface to RTM3205 is a fast and easy-to-use graphical interface that is compatible with your standard web browser. Simply point your browser to the IP address of RTM3205 and log in securely with HTTP over the Secure Socket Layer (SSL). Security-conscious customers may disable the HTTPS interface (see the end of this chapter for instructions).*

The HTTPS implementation in RTM3205 uses HTTP over SSL. SSL is a sublayer under standard HTTP. HTTPS enhances security because it encrypts and decrypts the requested and returned pages from the server, including any passwords which are transmitted.

The HTTPS implementation is built from the standard Apache/2.4.10 distribution from:

<http://httpd.apache.org>

See **Chapter 5 - Security, HTTPS** for information on changing the default HTTPS configuration and SSL certificate and key.

### IMPORTANT

A domain name server IP address is required by the Apache web server. When using `netconfig` (see **Chapter 3 - Console Port Control and Status**) to configure the TCP/IP parameters, be sure to configure a name server. Only one name server is required but two gives some redundancy. The HTTPS Interface will not operate properly if this is configured incorrectly.

## HTTPS Interface Description

For security reasons the web pages on RTM3205 show status and configuration information only. You cannot change any operational settings, however you can perform upgrades to RTM3205 firmware, which is done with several security measures in place. To make other changes to RTM3205 you will need to use the command line interface via either a network or serial port.

### NOTE

For proper operation, your web browser must be configured to allow pop-up windows.

To get started with the web interface simply point your browser to the IP address of RTM3205 and log in securely with HTTPS. Following are examples for IPv4 and IPv6:

IPv4: `http://192.168.1.1`

IPv6: `http://[fe80:0:0:0:20e:f3ff:fe01:1f]` Do not forget the brackets [].

A warning dialog page will be presented for the certificate. Acknowledge the dialog page and the server will continue to load, protected by SSL. The browser should change from `http:` to `https:`, indicating that the page is protected by SSL. To maximize security you should replace the SSL Certificate. See *Chapter 5 - Security, HTTPS* for details.

Below is a picture of the login page:

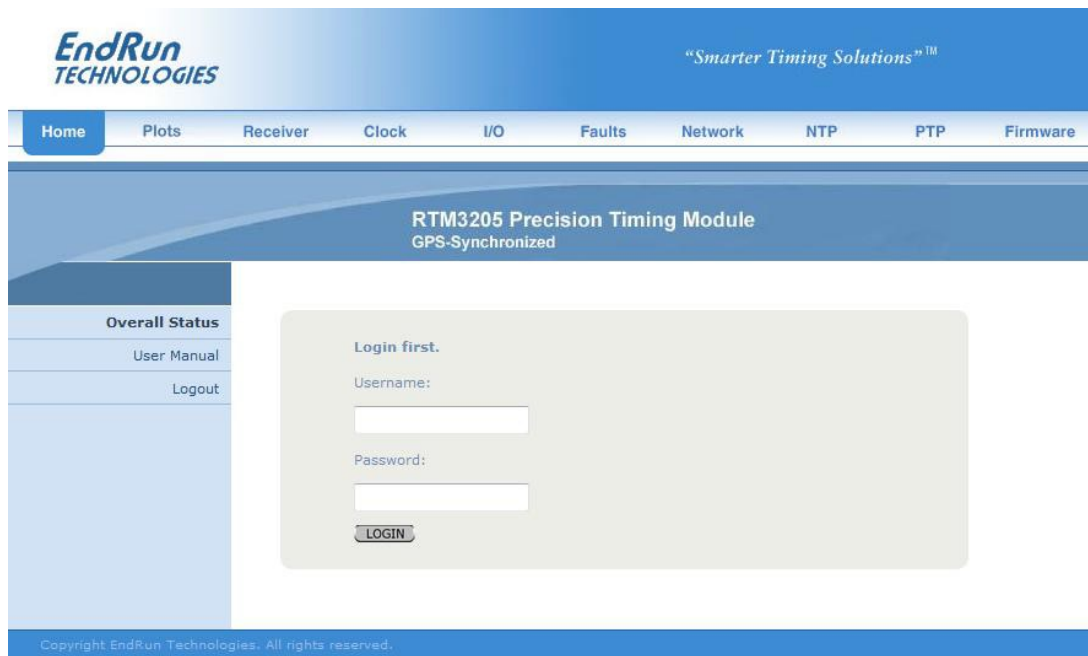

**Navigation**

The main menu tabs across the top of each webpage allow you to navigate through the status information in RTM3205 while links on the left side of each webpage provide subcategory navigation.

For example, in the page below the main menu tabs are: Home, Receiver, Plots, Clock, I/O, Faults, Network, NTP, PTP and Firmware. The tabs across the top and the left-side links are logically arranged for easy navigation.



**Page Descriptions**

**Home: Overall Status Page**

Data fields for this page are described below.

Overall Status

Model RTM3205

Serial Number Serial number of the RTM3205.

UTC Time, UTC Date The current UTC date and time is shown. This date will show year 1980 if the time has not yet been acquired.

Receiver	This is the locked status of the GPS Subsystem/Receiver as follows: WARMUP: Warmup period for units with oscillator upgrades. ACQUIRING: Acquiring. Searching for a signal. LOCKING: Locking to the GPS signal. LOCKED: Locked. Fully synchronized to signal.
TFOM	Shows the current TFOM value. See <i>Appendix A - TFOM</i> for more information.
System Status	This field indicates whether a system fault exists. Possible values are OK and FAULT. If it shows FAULT then go to the Faults Page to see which particular fault is the problem.

#### CPU Statistics

Current CPU temperature, CPU free memory and CPU load average are all shown.

#### **Home: User Manual**

This link provides access to the RTM3205 User Manual that is resident in the FLASH memory. The most recent version of the User Manual is on the EndRun website at:

<http://www.endruntechnologies.com/pdf/USM3205-0000-000.pdf>

#### **Home: Logout**

Clicking on this link will immediately log you out of the RTM3205 HTTPS Interface.

#### **Plots Page**

Information available on this page are statistics related to the GPS Receiver. Links on the right give access to the daily plot files - going back up to 10 years. Links on the left give access to performance statistics for CPU, Receiver, NTP, and Oscillator. (If your unit has the RTIC Option, then an Ionosphere plot is also available). A sample data plot is shown below:



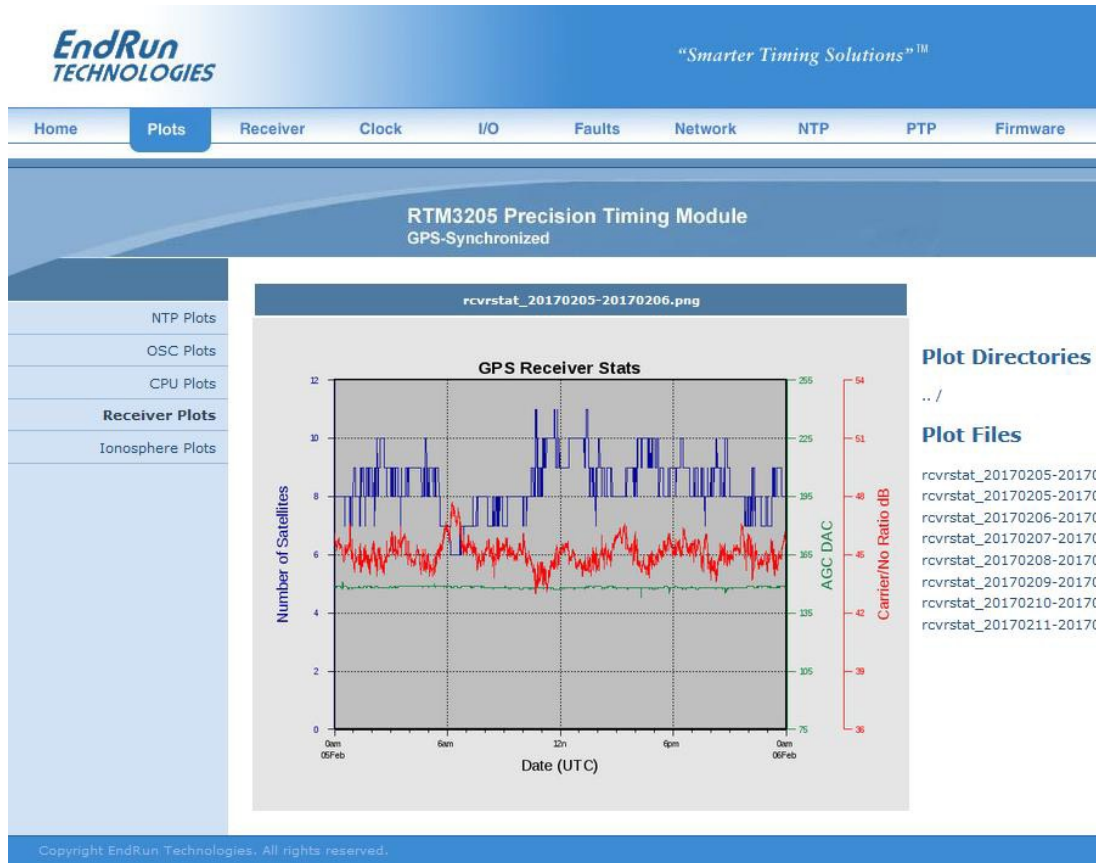

There are four or five types of data plots available for viewing: CPU, Receiver, NTP, Oscillator and Ionosphere (if RTIC Option enabled). The large data plot shown on any of the plot pages is the last data plot viewed. This could be from any one of the data types (CPU, Receiver, NTP, Oscillator, Ionosphere).

All plot files are kept in directories. There is one directory for each week. To choose a new plot to view, use the selections on the right side of the page. First, click to select a directory. Then you can either click to select one of the listed plot files, or you can use your mouse to hover over one of the plot files. Hovering over a plot file will display a small plot next to the large main plot. In this way you can compare plots from different types to correlate data. For example, you can compare an NTP data plot with a CPU data plot.

Plots files can also be downloaded from RTM3205 as .PNG files. They can be found in the directory */logs/png*.

### Receiver: Receiver Page

This page contains information related to the GPS Subsystem/Receiver. Data fields are described below.

Subsystem Status

State	Shows the current state of the GPS Subsystem. WARMUP: Warmup period for units with oscillator upgrades. ACQUIRING: Acquiring. Searching for a signal. LOCKING: Locking to the GPS signal. LOCKED: Locked. Fully synchronized to signal.
TFOM	Shows the current TFOM value. See <i>Appendix A - TFOM</i> for more information.

GPS Receiver Status

State	Shows the current state of the GPS Receiver. WARMUP: Warmup period for units with oscillator upgrades. ACQUIRING: Acquiring. Searching for a signal. LOCKING: Locking to the GPS signal. LOCKED: Locked. Fully synchronized to signal.
Satellite ID	This field lists the satellites that are currently being tracked. Up to 12 may be tracked at a time. Click on the Satellite-Info link for details.
AGC	Automatic Gain Control DAC. Typical value is 150 to 200 in good signal conditions.
Average C/No	The carrier-to-noise ratio is an indicator of the GPS signal quality. This number typically ranges from 39 to 50 dB when RTM3205 is locked.
GPS Dynamic Mode	This field shows whether the dynamic mode is set or not. Dynamic mode should be OFF when RTM3205 is in a static (not moving) position. To change the dynamic mode setting use the <b>gpsdynmode</b> command.

WGS-84 Reference Position

Position Source	The source of the reference position can be: UNK: Unknown position. DYN: Dynamic. Position determined while in Dynamic Mode. USR: User-entered reference position. AVG: Average is a 24-hour average of GPS fixes. To change the reference position source use the <b>gpsrefpos</b> command.
Latitude, Longitude, Height	The WGS-84 latitude and longitude in degrees, minutes and seconds format, and the height above the WGS-84 reference ellipsoid in meters is shown. Refer to <i>Appendix D - Installing the GPS Antenna, About WGS-84</i> .
RMS PDOP, Average Count	The current RMS PDOP of the average position and the current count of averages are shown. If the reference position source is not AVG, then these two values will be zero.

---

## HTTPS INTERFACE

### WGS-84 Last Position Fix

Latitude, Longitude, Height These fields show information for the most recent position fix. The WGS-84 latitude and longitude in degrees, minutes, seconds format and the height above the WGS-84 reference ellipsoid in meters is shown. Refer to *Appendix D - Installing the GPS Antenna, About WGS-84*.

PDOP, HDOP, VDOP, TDOP DOP stands for Dilution-of-Precision.

Out-of-Range Count The out-of-range counter may be non-zero when RTM3205 has been moved more than 1 km from its previous location without being placed in UNKNOWN mode. (See the `setgpsrefpos` command.)

### GPS-UTC Almanac Info

These fields show the IS-GPS-200 almanac parameters which are used to relate GPS time to UTC.

LS, LSF These fields contain the current leap second and future leap second values.

WNLSF, DN These fields show the GPS week number and day number of week at the end of which the future leap second will take effect. This could be in the past if a leap second insertion has recently taken place. Leap second events typically occur every one-and-a-half to three years on either June 30 or December 31.

A0, A1, WNt, tot These fields show the parameters for calculating the small residual offset between the GPS master clock ensemble and UTC(USNO). This is typically less than 10 nanoseconds.

Current (GPS-UTC) This is the current value of the GPS-UTC offset, which includes leap seconds plus the small residual offset explained above. Time and date of most recently received satellite transmission containing this data is also shown.

### GPS Ionosphere Almanac Info

The information shown here is the broadcast GPS almanac parameters for the Klobuchar ionospheric delay model. Two sets of model parameters are shown. The first (alpha) is the most recently received set. The second (beta) is the previously received set. The GPS week number and time of week are also shown.

### Real-Time Ionospheric Corrections (Optional)

This section is for the optional RTIC. If your RTM3205 does not have RTIC, then this section will not be shown. For more information on RTIC see *Chapter 11 - Real-Time Ionospheric Corrections*.

### Configuration

Clock Calibration Clock calibration is used to advance or retard the clock in order to correct for GPS Receiver delay and any propagation delay due to GPS antenna cable. It may also be used to compensate for the inherent time offsets that may exist with external hardware such as distribution amplifiers, etc. Calibration range is  $\pm 500,000$  nanoseconds.

**Receiver: Oscillator Page**

This page shows system oscillator control information for the GPS Subsystem:

Oscillator Status

Oscillator Type	This field shows the system oscillator type that is installed in the RTM3205. It will be either the MS-OCXO, HS-OCXO, or US-OCXO.
DAC	The system oscillator control DAC value indicates the frequency control setting. The system automatically sets this value to remove frequency errors. Values may range from 0 to 1,048,575. Values close to the minimum or maximum will set the DAC fault flag.
Measured Time Error	This field shows the last measured time offset of the GPS Subsystem relative to GPS while locked, in second.
Time Deviation	This field shows the time deviation (TDEV) of the offset measurements in seconds. The tau associated with this measurement is one second, which is the update interval of the position fixes received from the GPS Receiver.
Oscillator Ageing Rate	This field shows the regression-computed system oscillator ageing rate per day (several-hours delay before the first measurements are displayed).
Control Loop TAU	This field shows the system oscillator control loop averaging time constant, in seconds. It's value is automatically adjusted to maintain optimum offset and stability.
Coast Duration	This shows the number of seconds the GPS Subsystem has been in coast mode, while RTM3205 is unlocked to GPS. Coast mode is another term for holdover mode.
Estimated Time Error	This is the estimated time error of the GPS Subsystem when in coast/holdover mode, in seconds.
Internal Chassis Temperature	Internal chassis temperature in °C.

**Clock Page**

This page shows the configuration of the RTM3205 except for any optional I/O which is listed on the I/O page.

Clock Configuration

Time Mode	This field shows the current time mode setting. Possible settings are UTC, GPS and Local. Since NTP always uses UTC, this setting only affects the Time Code Output and optional Serial Time Output. To change the time mode setting use the <b>systemmodeconfig</b> command via the console port.
-----------	--

Time Zone Offset	This field shows the offset from UTC and is only valid when the Time Mode is Local. A positive Time Zone Offset implies a longitude east of the Greenwich Tycho. To change the time zone use the <b>systemodeconfig</b> command.
Daylight Saving Time	This field will show whether DST control is enabled or not. DST fields are only used when the Time Mode is Local.
DST Start, DST End	These fields will only display if the Daylight Saving Time field above shows enabled. If enabled, then these fields show when DST starts and ends during the year. For example, in most of the U.S.A. the DST Start Time is the 2nd Sunday in March at 2 a.m. The DST End Time is the 1st Sunday in November at 2 a.m. DST settings are used when the time mode is Local. To change the DST settings use the <b>systemodeconfig</b> command.

### **I/O Page**

This page shows the optional outputs and their settings. Use commands **cpuoptsconfig** and **sysioconfig** via the console port to change the settings of these outputs. See *Chapter 10 - Inputs/Outputs* for information on the various options.

### **Faults: System Faults Page**

This page lists all possible system fault conditions of RTM3205 - the Linux Subsystem, the GPS Subsystem and the GPS Receiver. For details on each fault see *Appendix G - System Faults*.

### **Faults: Fault Mask Page**

#### Fault Masks

Signal Fault	This field shows the current mask setting for the Signal Fault, either Masked or Enabled. When the signal fault is Masked it will prevent a Signal Loss Fault from occurring. Some installations may need to mask this fault when operating RTM3205 with no GPS signal. (An example of this would be when configured as a Stratum 2 NTP Server.) To change the Signal Fault Mask use the <b>setsigfltmask</b> command.
Antenna Fault	This field shows the current mask setting for the Antenna Fault. When the antenna fault is Masked it will prevent an Antenna Fault from occurring. Some installations may need to mask this fault due to special antenna situations like splitters. To change the Antenna Fault Mask use the <b>setantfltmask</b> command.

### **Faults: TFOM Fault Level Page**

This is the threshold at which a signal loss fault will be asserted. See *Appendix A - Time Figure of Merit* for more information. You can change the TFOM Fault Level by using the **settfomflt1vl** command. The factory default setting is 9, which is the maximum TFOM value.

**Faults: Receiver Faults Page**

This page lists all possible system fault conditions of the GPS Receiver. For details on each fault see *Appendix G - System Faults*.

**Network: IPv4 Page**

This page shows the IPv4 network configuration.

IPv4 Network Status

DHCP By default, RTM3205 will configure itself using the Dynamic Host Configuration Protocol (DHCP). If you need to set up static IP configuration, you must use the **netconfig** command via the console port. This field will show whether DHCP is enabled or disabled.

Address, Gateway These fields show the settings for the IP address, gateway and netmask.

Netmask To change these settings use the **netconfig** command via the console port.

**Network: IPv6 Page**

This page shows information related to the IPv6 network parameters. For more information on IPv6 see *Chapter 8 - IPv6 Information*.

**Network: DNS Page**

This page shows the IP addresses of the primary and secondary domain name servers.

**Network: MAC Address Page**

This page shows the media-access-control (MAC) address for both Ethernet ports (**eth0** and **eth1**).

**NTP Page**

The NTP Status page shows all information related to NTP operation.

NTP Status

Status	The stratum field has several possible values: Stratum 1: The server is fully synchronized and accurate. Stratum 2: The server is synchronized to a Stratum 1 server. Stratum x: The server is synchronized to a Stratum x-1 server. Stratum 16: The server is unsynchronized. NTP clients will not use a Stratum 16 server.
Source	This field will show the source of time which is usually GPS. If RTM3205 is configured as a Stratum 2 server then it will show the IP address of the upstream Stratum 1 server.
Offset	This field shows the offset in seconds between the NTP system clock and the GPS Subsystem clock. Positive implies that the NTP system clock is ahead of the GPS Subsystem clock.

Leap Indicator Bits      This field shows whether a leap second is pending. Leap second events occur approximately every 2-3 years as announced by the International Earth Rotation and Reference Systems Service (IERS). Possible indicator values are:

00:	Normal, locked operation.
01:	Leap second insertion event will occur after 23:59:59 UTC.
11:	Fault. Unsynchronized state.

### I/O Statistics

Time Since Reset,      These fields show statistics accumulated since the last reboot of the system.  
Packets Sent/Received,  
Packets Sent Rate,  
Packets Dropped

## **PTP: Status and Configuration Pages**

The fields on these pages show the status and the configuration for the optional PTP/IEEE-1588 protocol. If your RTM3205 does not have PTP enabled then there will be no fields shown. For more information on PTP and an explanation of the data fields on this page see *Chapter 4 - PTP/IEEE-1588*.

## **Firmware: Firmware Status Page**

The firmware status page shows part numbers and revisions for RTM3205 firmware components which are: Linux Root File System (RFS), Linux Kernel, GPS Subsystem, GPS Subsystem FPGA and GPS Receiver. RTM3205 also has two Field-Programmable Gate Arrays which are: GPS Subsystem FPGA and GPS Receiver FPGA.

## **Firmware: Linux RFS Upgrade Page**

This page is used for upgrading the Linux RFS firmware. You must be logged in as “root” in order to have access to this page. The latest released versions of RTM3205 firmware are freely available on the EndRun Technologies website. For detailed information on how to perform the upgrade either via the network port, the serial port, or the HTTPS interface see *Appendix B - Upgrading The Firmware*.

## **Firmware: Linux Kernel Upgrade**

This page is used for upgrading the Linux Kernel firmware. You must be logged in as “root” in order to have access to this page. The latest released versions of RTM3205 firmware are freely available on the EndRun Technologies website. For detailed information on how to perform the upgrade either via the network port, the serial port, or the HTTPS interface see *Appendix B - Upgrading The Firmware*.

## **Firmware: GPS Subsystem Upgrade Page**

This page is used for upgrading the firmware. You must be logged in as “root” in order to have access to these pages. The latest released versions of RTM3205 firmware are freely available on the EndRun Technologies website. For detailed information on how to perform the upgrade either via the network port, the serial port, or the HTTPS interface see *Appendix B - Upgrading The Firmware*.

**Firmware: GPS Receiver Upgrade Page**

This page is used for upgrading the firmware for the GPS Receiver. You must be logged in as “root” in order to have access to these pages. The latest released versions of RTM3205 firmware are freely available on the EndRun Technologies website. For detailed information on how to perform the upgrade either via the network port, the serial port, or the HTTPS interface see *Appendix B - Upgrading The Firmware*.

**Firmware: Reboot Page**

This page will allow you to perform a software reboot of both the Linux Subsystem and the GPS Subsystem. This is normally used after a firmware upgrade but can be done anytime you wish to reset the RTM3205.

**Disable or Restrict Access**

To disable HTTPS, see *Chapter 5 - Security, Disable SNMP, SSH and HTTPS*. To restrict access to specific hosts see *Chapter 5 - Security, Restrict Access - HTTPS*.



# Chapter Five

## Security

Your RTM3205 Precision Timing Module incorporates several important security features to prevent unauthorized tampering with its operation. Many of these are standard multiple-user access control features of the underlying Linux operating system which controls the RTM3205. Others are provided by the additional protocol servers selected for inclusion in your RTM3205, and the way that they are configured.

Secure user authentication and session privacy while performing routine monitoring and maintenance tasks are provided by the OpenSSH implementations of the “secure shell” daemon, **sshd** and its companion “secure copy” utility, **scp**. The Apache implementation of the Hyper Text Transfer Protocol (HTTPS) with Secure Sockets Layer (SSL) daemon (**httpd**) provides for a secure, encrypted session with a digital certificate. The NET-SNMP implementation of the Simple Network Management Protocol (SNMP) daemon, **snmpd** conforms to the latest Internet standard, known as SNMPv3, which also supports secure user authentication and session privacy. In addition, the Network Time Protocol daemon, **ntpd** supports client-server authentication security measures to deter spoofing of NTP clients by rogue NTP servers. This chapter describes these security measures and gives the advanced network administrator information that will allow custom configuration to fit specific security needs.

### IMPORTANT

SSH, Telnet, SNMP and HTTPS are all enabled with default passwords. To ensure security, change the passwords or disable the protocols. To change the passwords for SSH, Telnet and HTTPS use the **passwd** command. To change the passwords/community strings for SNMP see **Chapter 6 - SNMP**.

By default all hosts are allowed access via SSH, Telnet and SNMP. To restrict access via these protocols to specific hosts, see **Restrict Access - Telnet, SSH and SNMP** below. All hosts are allowed access via HTTPS as well. To restrict access via HTTPS, see **Restrict Access - HTTPS** below.

To completely disable any or all of these protocols see **Disable Protocols** below.

## Linux Operating System

The Linux operating system versions are shown in **Appendix K - Specifications**. Linux supports a complete set of security provisions:

- System passwords are kept in an encrypted file, */etc/shadow* which is not accessible by users other than *root*.

- Direct *root* logins are only permitted on the local RS-232 console or via SSH.
- The secure copy utility, **scp**, eliminates the need to use the insecure FTP protocol for transferring program updates to RTM3205.
- HTTP access for system monitoring only, is allowed only via SSL, so passwords and session data are encrypted on the wire. Access via HTTPS may be restricted or completely disabled. See *Restrict Access - HTTPS* and *Disable SNMP, SSH and HTTPS* below.
- SNMP access for system monitoring only, is configurable to provide the security of the latest version 3 Internet standard which supports both view-based access control and user-based security using modern encryption techniques. Previous versions v1 and v2c supported access control essentially via passwords transmitted over the network in plain text. Refer to *Chapter 6 - SNMP* and *Restrict Access - Telnet, SSH and SNMP* (below) for details. SNMP may also be completely disabled. See *Disable SNMP, SSH and HTTPS* below.
- Individual host access to protocol server daemons **in.telnetd**, **snmpd** or **sshd** are controlled by directives contained in the files */etc/hosts.allow* and */etc/hosts.deny*, which are configured using the interactive script **accessconfig**. See *Restrict Access - Telnet, SSH and SNMP* below.
- Insecure protocols like Time, Daytime and Telnet may be completely disabled by configuration of the **inetd** super-server daemon using the interactive script **inetdconfig**. See *Disable Telnet, Time and Daytime* below.

## Restrict Access

The following paragraphs describe how to restrict SNMP, SSH, Telnet and HTTPS access to specific hosts. Also described is how to restrict NTP query access.

### Restrict Access - Telnet, SSH and SNMP

By default, RTM3205 is configured to allow access by all users via Telnet, SSH and SNMP. To ensure security and to protect against denial-of-service attacks, you should restrict access by using the **accessconfig** command.

**accessconfig** modifies two files, */etc/hosts.allow* and */etc/hosts.deny*, which are used by **tcpd** and the standalone daemons, **snmpd** and **sshd**, to determine whether or not to grant access to a requesting host. These two files may contain configuration information for a number of protocol servers, but in RTM3205 only access control to the protocol server daemons **in.telnetd**, **sshd** and **snmpd** is configured.

As shipped from the factory, these two files are empty. When you run **accessconfig**, these lines are added to the */etc/hosts.deny* file:

```
in.telnetd: ALL  
sshd: ALL  
snmpd: ALL
```

---

## SECURITY

This tells `tcpd` to deny access to `in.telnetd`, `sshd` and `snmpd` to all hosts not listed in the `/etc/hosts.allow` file. The `snmpd` and `sshd` daemons also parse this file directly prior to granting access to a requesting host.

Next you will be prompted to enter a list of hosts that will be granted access to `in.telnetd`, `sshd` and `snmpd`. These appear in the `/etc/hosts.allow` as lines like this:

```
in.telnetd: 192.168.1.2, 192.168.1.3
sshd: 192.168.1.2, 192.168.1.3
snmpd: 192.168.1.2, 192.168.1.3
```

This simple shell script handles the needs of most users, however the syntax of these two files supports elaborate configuration possibilities which are beyond the capabilities of this simple shell script. Advanced users who need these capabilities will need to edit these two files directly and then copy them to the `/boot/etc` directory. (See *Appendix C - Helpful Linux Information, Using Editors*.) Be careful to maintain the proper ownership and access permissions by using `cp -p` when copying the files.

### Restrict Access - HTTPS

To control access via HTTPS, you must edit the `/etc/httpd/httpd.conf` file and add the equivalent deny followed by allow directives. For example, the default file contains these lines:

```
<Directory "srv/httpd/cgi-bin">
  AllowOverride None
  Options None
  Require all granted
</Directory>
```

To complete the configuration steps to restrict access and allow a specific host with IP address `xxx.xxx.xxx.xxx`, you would modify the directives as follows:

```
<Directory "srv/httpd/cgi-bin">
  AllowOverride None
  Options None
  Require ip xxx.xxx.xxx.xxx
# Require all granted
</Directory>
```

After making and saving your changes, you must copy the edited file to the non-volatile FLASH area and reboot the unit:

```
cp -p /etc/httpd/httpd.conf /boot/etc/httpd
reboot
```

## Restrict Query Access - NTP

The Network Time Protocol (NTP) implementation in RTM3205 is built from the reference distribution from:

<http://www.ntp.org>

By factory default, remote control and query of the NTP daemon **ntpd** is disabled. Query-only operation is supported only from processes running on RTM3205 itself, i.e. from the *localhost*. This restricts access to **ntpd** from remote hosts using either of the two NTP companion utilities **ntpq** and **ntpdc**.

Control via these two utilities is disabled in the */etc/ntp.conf* file in two ways. First, MD5 authentication keys are not defined for control operation via a *requestkey* or *controlkey* declaration. Second, this default address restriction line is present in the file:

```
restrict default nomodify noquery nopeer
restrict 127.0.0.1 nomodify
restrict 0:::1 nomodify
```

The first line eliminates control and query access from ALL hosts. The second and third lines disable the localhost from making any modifications to the **ntpd** daemon, but query access is not affected by this restriction. These lines must not be removed, as they are necessary for various monitoring processes running on RTM3205 to function properly.

Knowledgeable NTP users who would like to customize the security aspects of the configuration of the NTP daemon in RTM3205 should edit the */etc/ntp.conf* file directly and then copy it to the */boot/etc* directory. Be sure to retain the ownership and permissions of the original file by using **cp -p** when performing the copy.

### CAUTION

If you are planning to make changes to the */etc/ntp.conf* file, you must NOT restrict query access from the local host to the NTP daemon. Various system monitoring processes running on the system require this access.

An example follows which shows how to allow query access from a specific remote host with IP address 192.168.1.10 while also allowing processes running on RTM3205 to have query access as well:

```
restrict default noquery nomodify nopeer
restrict 127.0.0.1 nomodify
restrict 0:::1 nomodify
restrict 192.168.1.10 nomodify
```

## Disable Protocols

See below for instructions on how to completely disable the following protocols: Telnet, Time, Daytime, SSH, SNMP, and HTTPS. See *Chapter 9 - PTP/IEEE-1588 Option* for how to disable PTP. The Network Time Protocol (NTP) cannot be disabled.

### Disable Telnet, Time and Daytime

To disable Telnet, Time and Daytime use the `inetdconfig` command to start an interactive script that will ask you which protocols to disable. Then it will modify the `/etc/inetd.conf` file, which is read by the super-server daemon, `inetd`. Requests from remote hosts for protocols not configured in `/etc/inetd.conf` will be refused. Currently, three servers are configurable via `inetdconfig`: Time and Daytime (whose protocol servers are contained within the `inetd` daemon itself), and `in.telnetd`. Any one or all of these may be enabled or disabled for start-up.

### Disable SNMP, SSH and HTTPS

To disable SNMP, SSH or HTTPS, you only have to modify the file mode of the scripts that control their execution. These are located in the `/etc/rc.d` directory. To disable any of these daemons, issue one or more of these commands:

```
chmod -x /etc/rc.d/rc.snmpd
chmod -x /etc/rc.d/rc.sshd
chmod -x /etc/rc.d/rc.httpd
```

After issuing these commands, you must copy the modified file(s) to the non-volatile FLASH area using one or more of these commands:

```
cp -p /etc/rc.d/rc.snmpd /boot/etc/rc.d
cp -p /etc/rc.d/rc.sshd /boot/etc/rc.d
cp -p /etc/rc.d/rc.httpd /boot/etc/rc.d
```

Reboot RTM3205 when done for the changes to take effect.

### IMPORTANT

After modifying `/etc/rc.d/rc.snmpd`, `rc.sshd` or `rc.httpd`, you must copy them to the `/boot/etc/rc.d` directory and reboot the system. It is very important to use the `-p` when performing the copy. During the boot process, the files contained in the `/boot/etc/rc.d` directory are copied to the working `/etc/rc.d` directory on the system RAM disk. In this way the factory defaults are overwritten.

### Re-Enable SNMP, SSH and HTTPS

If you have disabled SNMP, SSH or HTTPS, and you want to re-enable it, all you need to do is remove the `rc` file from the `/boot/etc/rc.d` directory using one or more of these commands:

```
rm /boot/etc/rc.d/rc.snmpd
rm /boot/etc/rc.d/rc.sshd
rm /boot/etc/rc.d/rc.httpd
```

Reboot RTM3205 when done for the changes to take effect.

### Is the Protocol Disabled?

Telnet, TIME and DAYTIME: To determine if one of these protocols is disabled, use the `inetdconfig` command.

SNMP, SSH and HTTPS: To determine if one of these protocols is disabled, issue the following command:

```
ls -l /boot/etc/rc.d
```

If you see one of the following files listed, and there is NOT an ‘\*’ after the file name, then the corresponding protocol is disabled:

```
-rw-r--r-- 1 root root 1144 Feb 19 01:52 rc.httpd
-rw-r--r-- 1 root root 1168 Oct 26 2012 rc.snmpd
-rw-r--r-- 1 root root 2684 Feb 18 02:16 rc.sshd
```

If rc.httpd, rc.snmp, or rc.ssh is not listed, or it is listed and there is an ‘\*’ after the file name, then the protocol is enabled. Here is an example:

```
-rwxr-xr-x 1 root root 1168 Oct 26 2012 rc.snmpd*
```

## OpenSSH

The secure shell protocol server running in RTM3205 is based on the portable OpenSSH for Linux. As such it supports both SSH1 and SSH2 protocol versions. By default, only SSH2 is enabled in RTM3205 due to security issues with SSH1. For more information about OpenSSH, and to obtain client software, refer to the OpenSSH website:

<http://www.openssh.com>

An excellent book which describes operation and configuration of the various SSH implementations, including OpenSSH is:

*SSH, The Secure Shell*, Barrett & Silverman, O’Reilly & Associates, 2001.

NOTE: To disable the SSH protocol see *Disable SNMP, SSH and HTTPS* above. To restrict access see *Restrict Access - Telnet, SSH and SNMP* above.

### Configure Keys

On initial boot-up from out-of-the-box, the SSH start-up script, `/etc/rc.d/rc.sshd`, will detect that no keys are present in the `/etc/ssh` directory. It will call `ssh-keygen` to generate a set of host keys and then it will copy them to the `/boot/etc/ssh` directory. These will be copied to `/etc/ssh` during each boot up. A complete set of security keys for both SSH1 and SSH2 versions of the protocol are generated. RSA keys are supported by both versions, and DSA keys are supported when using the SSH2 version.

Should you need to replace your keys at any time, you can just remove the keys from the `/boot/etc/ssh` directory and then reboot RTM3205. A new set of host keys will automatically be generated.

To configure root logins to your RTM3205 via passwordless, public key authentication, you must generate a public/private pair of SSH2 keys using your own ssh key generating utility, or you can use the `ssh-keygen` that is resident on RTM3205 file system. You must then append the public key to the `/boot/root/.ssh/authorized_keys` file in the non-volatile FLASH area on your RTM3205. At boot time, RTM3205 will copy these to the actual working `/root/.ssh` directory of the system ramdisk. To use this capability, the corresponding private key must reside in the `/root/.ssh` directory of your remote computer as `id_rsa` or `id_dsa`. If you are unfamiliar with this process, refer to the man page for the `ssh-keygen` utility for details (issue `man ssh-keygen` at the prompt). (Be careful to maintain the proper ownership and access permissions of the private key by using `cp -p` when copying the file. It MUST be readable only by `root`.)

Advanced users wishing to modify the overall configuration of the `sshd` daemon should edit the `/etc/ssh/sshd_config` file and then copy it to the `/boot/etc/ssh` directory of RTM3205. Be careful to maintain the proper ownership and access permissions by using `cp -p` when copying the file. At boot time, it will be copied to the `/etc/ssh` directory of the system ramdisk, thereby replacing the factory default configuration file.

## HTTPS

The HTTPS server in RTM3205 is built from the standard Apache version 2.4.10 distribution from:

<http://httpd.apache.org>

It uses HTTPS (HTTP over SSL) with `mod_ssl` (the Apache interface to OpenSSL). For more information about this protocol, refer to:

<http://www.modssl.org>

NOTE: To disable the HTTPS protocol see **Disable SNMP, SSH and HTTPS** above. To restrict access see **Restrict Access - HTTPS** above.

HTTPS and SSL use files for the default configuration located in `/etc/httpd`. Of these, you will typically only need to modify `httpd.conf`. Advanced users who need to modify the default configuration will need to edit the file and copy it to the `/boot/etc/httpd` directory. Do not attempt to change the directives unless you have a real need to do so. (See **Appendix C - Helpful Linux Information, Using Editors** above.)

### Configure Certificate and Key

For SSL it is recommended, but not required, that new certificates and keys are generated and installed on the Apache web server with `mod_ssl`. The factory configured, self-signed certificate is located in `/etc/httpd/server.crt`, and the key in `/etc/httpd/server.key`. After creating new certificates and private keys, they will need to be saved in `/boot/etc/httpd/server.crt` and `/boot/etc/httpd/server.key`. To generate a new certificate and key, issue these commands:

```
cd /boot/etc/httpd
openssl req -new -x509 -nodes -out server.crt -keyout server.key
```

The two files will be created in the `/boot/etc/httpd` directory. You must reboot RTM3205 for them to take effect. An excellent book which describes operation and configuration of the various HTTPS directives and SSL configuration is:

*Professional Apache*, Wainwright, Wrox Press, 1999.

## **NTP**

You can configure your NTP clients for secure MD5 authentication. See *Chapter 7 - NTP, Unix-like Platforms: MD5 Authenticated NTP Client Setup* or *Chapter 7 - NTP, Windows: MD5 Authenticated NTP Client Setup*. You can also restrict NTP query access. See *Restrict Query Access - NTP* in this chapter.

## **Network Security Vulnerabilities**

EndRun addresses major network security vulnerabilities that affect RTM3205 at the top of this webpage:

<http://www.endruntechnologies.com/fsb.htm>

This Application Note describes best practices to secure your time server and mitigate many network security vulnerabilities:

<http://www.endruntechnologies.com/pdf/AppNoteSecurity.pdf>



# Chapter Six

## *Simple Network Management Protocol (SNMP)*

Your RTM3205 Precision Timing Module includes the NET-SNMP version 5.5.1 implementation of an SNMP agent, `snmpd`, and a SNMP notification/trap generation utility, `snmptrap`. It supports all versions of the protocol in use today: SNMPv1 (the original Internet standard), SNMPv2c (never reached standard status, often called “community SNMP”) and SNMPv3 (the latest Internet standard).

The NET-SNMP project has its roots in the Carnegie-Mellon University SNMP implementation. For more detailed information about the NET-SNMP project and to obtain management software and detailed configuration information, you can visit this website:

<http://www.net-snmp.org>

An excellent book which describes operation and configuration of various SNMP managers and agents, including the NET-SNMP implementations, is available from O’Reilly & Associates:

*Essential SNMP*, Mauro & Schmidt, O’Reilly & Associates, 2001

If you are planning to operate with SNMPv3, it is highly recommended that you make use of both of these resources to familiarize yourself with the agent configuration concepts.

### **SNMPv3 Security**

Prior to SNMPv3, SNMP had definite security inadequacies due to using two community names in a manner analogous to passwords that were transmitted over the network as clear text. In addition, since no mechanism existed for authenticating or encrypting session data, any number of man-in-the-middle data corruption/replacement exploits were possible in addition to plain old snooping to learn the community names. SNMPv3 implements the User-based Security Model (USM) defined in RFC-2274 which employs modern cryptographic technologies to both authenticate multiple users and to encrypt their session data for privacy, much in the same way that SSH does for remote login shell users.

In addition, it implements the View-based Access Control Model (VACM) defined in RFC-2275. This RFC defines mechanisms for limiting the access of multiple users having various security levels (no authentication, authentication or authentication plus privacy) to specific “views” of the Structure of Management Information (SMI) object tree.

## Enterprise Management Information Base (MIB)

In addition to providing the SNMP variables contained in MIB-II as described in RFC-1213, EndRun Technologies has implemented an enterprise MIB using the syntax of the SMI version 2 (SMIv2) as described in RFC-2578:

RTM3205-MIB

Which is located on your RTM3205 in this ASCII file:

```
/usr/local/share/snmp/mibs/RTM3205-MIB.txt
```

In addition to a complete set of NTP and Receiver (GPS) status objects, the MIB defines four SMIv2 notification objects:

- NTP Leap Indicator Bits status change
- NTP Stratum change
- Receiver Fault Status change
- Receiver Time Figure of Merit change

## Invocation of the SNMP daemon

The SNMP daemon, `snmpd` is started from the `/etc/rc.d/rc.snmpd` system start-up script. By default, it will listen on port 161 for SNMP queries from the network management system. If you would like to have it listen on another port, you could edit the file and change the port number in the argument list being passed to `snmpd` when it is started.

### IMPORTANT

After modifying `/etc/rc.d/rc.snmpd`, you must copy it to the `/boot/etc/rc.d` directory and reboot the system. It is very important to retain the access mode for the file, so be sure to use `cp -p` when performing the copy. During the boot process, the files contained in the `/boot/etc/rc.d` directory are copied to the working `/etc/rc.d` directory on the system RAM disk. In this way the factory defaults are overwritten.

## Quick Start Configuration -- SNMPv1/v2c

You should be able to compile the RTM3205-MIB file on your SNMP management system and access the variables defined therein. The factory default community names are “RTM3205” for the read-only community and “endrun\_1” for the read-write community. This is all that is required for operation under v1 and v2c of SNMP.

### Change Default Community Strings (Passwords)

You can, and should, change the default community names by editing */etc/snmpd.conf* and modifying these two lines:

```
rwcommunity  endrun_1
rocommunity  RTM3205
```

## Configuring SNMPv1 Trap Generation

To have your RTM3205 send SNMPv1 traps (RFC-1215) you must configure the community and destination for SNMPv1 traps by uncommenting and editing this line in */etc/snmpd.conf*:

```
trapsink      xxx.xxx.xxx.xxx trapcommunity trapport
```

where **trapcommunity** should be replaced by your community, and **xxx.xxx.xxx.xxx** is the IP address or hostname of the destination host for receiving the traps generated by RTM3205. By default, the trap will be sent to port 162. You may optionally add another parameter, **trapport** to the end of the above line to override the default port setting. Otherwise leave it blank.

Note: Though the agent will recognize multiple **trapsink** lines within */etc/snmpd.conf* and send the generic SNMP coldStart or authenticationFailure traps to multiple destinations, the RTM3205 enterprise MIB trap generation mechanism will only send a trap to the last declared **trapsink** in the file.

## Configuring SNMPv2c Notifications and Informs

To have your RTM3205 send SNMPv2c notifications (SMIv2, RFC-2578) or informs, you must configure the communities and destinations by uncommenting and editing one or both of these lines in */etc/snmpd.conf*:

```
trap2sink     xxx.xxx.xxx.xxx trap2community trap2port
informsink    xxx.xxx.xxx.xxx informcommunity informport
```

where **trap2community** and **informcommunity** should be replaced by your communities, and **xxx.xxx.xxx.xxx** is the IP address or hostname of the destination host for receiving the notifications or informs generated by RTM3205. By default, the v2c trap or inform will be sent to port 162. You may optionally add another parameter, **trap2port** or **informport** to the ends of the above lines to override the default port setting. Otherwise leave it blank.

Note: Though the **snmpd** agent will recognize multiple **trap2sink** or **informsink** lines within */etc/snmpd.conf* and send the generic SNMP coldStart or authenticationFailure notifications and informs to multiple destinations, the RTM3205 enterprise MIB notification/inform generation mechanism will only send a notification to the last declared **trap2sink**, and an inform to the last declared **informsink** in the file.

**IMPORTANT**

After editing */etc/snmpd.conf*, you must copy it to the */boot/etc* directory and reboot the system. It is very important to retain the access mode for the file (readable only by *root*), so be sure to use `cp -p` when performing the copy. During the boot process, the files contained in the */boot/etc* directory are copied to the working */etc* directory on the system RAM disk. In this way the factory defaults are overwritten.

**Configuration of SNMPv3**

If you are planning to use SNMPv3, you should definitely make use of the two resources mentioned previously (NET-SNMP website and *Essential SNMP*) and study them carefully. There are rather elaborate configuration options available when you are using v3. The instruction presented here will give you the flavor of the configuration but definitely not the full scope of possibilities. To access your RTM3205 via v3 of SNMP, you will have to configure two files:

```
/etc/snmpd.conf
/boot/net-snmp/snmpd.conf
```

The first file contains static configuration parameters that the agent uses to control access and to determine where to send notifications/traps. Other aspects of the agent's operation are also configurable in this file, but you should not need to modify those. To use the SNMPv3 capabilities of RTM3205, you must first set up user information and access limits for those users in */etc/snmpd.conf*. Uncomment and edit these two lines to define your v3 users and their access parameters:

```
rwuser root      priv .1
rouser RTM3205 auth .1.3.6.1.4.1.13827
```

The first line defines a SNMPv3 read-write user *root* whose minimum security level will be authenticated and encrypted for privacy (choices are noauth, auth and priv), and who will have read-write access to the entire *iso(1)* branch of the SMI object tree. The second line defines a SNMPv3 read-only user *RTM3205* whose minimum security level will be authenticated but not encrypted, and who will have read-only access to the entire *iso(1).org(3).dod(6).internet(1).private(4).enterprises(1).endRunTechnologiesMIB(13827)* branch of the SMI object tree. After adding the user lines to */etc/snmpd.conf*, copy it to the */boot/etc* directory using `cp -p`.

The second file is located on the non-volatile FLASH disk and is used by the SNMP agent to store "persistent data" that may be dynamic in nature. This may include the values of the MIB-II variables *sysLocation*, *sysContact* and *sysName* as well as any configured SNMPv3 user crypto keys. In order to use SNMPv3, you must configure user keys in this file for each SNMPv3 user that you have set up in */etc/snmpd.conf*. To do this, you must add lines to */boot/net-snmp/snmpd.conf* like these for each user:

```
createUser root      MD5 endrun_1 DES endrun_1
createUser RTM3205 SHA RTM3205_0
```

The first line will cause the agent, *snmpd* to create a user *root* who may be authenticated via Message Digest Algorithm 5 (MD5) with password *endrun\_1* and may use the Data Encryption Standard (DES) to encrypt the session data with passphrase *endrun\_1*. The second line will cause a user

*RTM3205* to be created who may be authenticated using the Secure Hash Algorithm (SHA) with password *RTM3205\_0*. Passwords and passphrases must have a *minimum* of 8 characters, or you will not be able to be authenticated.

### IMPORTANT

You must kill the `snmpd` daemon prior to editing, */boot/net-snmp/snmpd.conf*. Otherwise, the secret key creation may not complete properly. Issue the command `/etc/rc.d/rc.snmpd stop` to kill the `snmpd` daemon. You can verify that the `snmpd` daemon has been killed by issuing the `ps -e` command and verifying that it is not present.

After rebooting, the agent will read the */boot/net-snmp/snmpd.conf* configuration file and compute secret key(s) for each of the users and delete the `createUser` lines from the file. It will then write the secret key(s) to the file. These lines begin with the string, `usmUser`. In this way, un-encrypted passwords are not stored on the system.

### IMPORTANT

To generate new keys, stop the `snmpd` process, delete the existing `usmUser` key lines from the file */boot/net-snmp/snmpd.conf* and then add new `createUser` lines. Then reboot the system.

This example gives the simplest configuration to begin using SNMPv3 but doesn't make use of the full capabilities of the VACM in defining groups and views for fine-grained access control. The factory default */etc/snmpd.conf* file contains commented blocks of lines that can be uncommented to give you a basic configuration that uses the User-based Security Model (USM) described in RFC-2274 and the View-based Access Control Model (VACM) described in RFC-2275. The comments included in the file should help you in modifying it for your specific requirements.

## Configuring SNMPv3 Notifications and Informs

If you have followed the steps in *Configuration of SNMPv3* (above), then you are almost ready to use SNMPv3 notifications and informs.

SNMPv3 uses the same `trap2sink` and `informsink` directives in */etc/snmpd.conf* as SNMPv2c. The difference being that `snmptrap` requires authorization and authentication information be provided to it when sending SNMPv3 notifications and/or informs. This additional information comes from the `usmUser` records in */boot/net-snmp/snmpd.conf*. A `usmUser` record is a space delimited record on one line with the following fields:

<u>Field#</u>	<u>Field Name</u>	<u>Field Value</u>
1	usmUser	usmUser
2	usmStatus	[a number (most likely 1)]
3	userStorageType	[a number (most likely 3)]
4	engineID	[0x followed by a number string/hash]
5	name	[0x followed by a number string/hash]
6	secName	[0x followed by a number string/hash]
7	cloneFrom	[NULL, unless user was created from a clone]
8	authProtocol	[a dotted number representing: MD5, SHA, “”]
9	authKey	[0x followed by a number string/hash]
10	privProtocol	[a dotted number representing: DES, AES, “”]
11	privKey	[0x followed by a number string/hash]
12	userPublicString	[0x followed by a number string/hash]

**snmptrap** requires (depending on the level of security) the use of fields 4, 5, 8, 9, 10, and 11. Your SNMP management station(s) will need to be configured to handle these hashed values.

Additionally, in */etc/snmptraps.conf* you will need to change the setting for V3 to ON. Copy *snmptraps.conf* to */boot/etc/* after you have made those changes so settings will be saved through reboots with *cp -a snmptraps.conf /boot/etc/snmptraps.conf*.

You should leave V1V2C set to ON until you verify that you can receive SNMPv3 notifications/informs. Then you can change the value to OFF.

### Example of usmUser Record

1	2	3	4	5	6	7	8
<u>usmUser</u>	<u>userStatus</u>	<u>userStorageType</u>	<u>engineID</u>	<u>name</u>	<u>secName</u>	<u>cloneFrom</u>	<u>authProtocol</u>
usmUser	1	3	0x80001f8880f06ffc1df80b5960	0x726f6f7400	0x726f6f7400	NULL	.1.3.6.1.6.3.10.1.1.2
9		10		11		12	
<u>authKey</u>		<u>privProtocol</u>		<u>privKey</u>		<u>userPublicString</u>	
0xea5285876964b7fc8bbef3e6c380f63f		.1.3.6.1.6.3.10.1.2.2		0xea5285876964b7fc8bbef3e6c380f63f		0x	

The image above shows an example of a usmUser record, where the fields are:

<u>Field#</u>	<u>Example Field Value</u>
5 & 6	hashed from the value <i>root</i>
8	MD5
9	hashed from the value <i>endrun_1</i>
10	DES
11	hashed from the value <i>endrun_1</i>

## Disable or Restrict Access

To disable SNMP, see *Chapter 5 - Security, Disable SNMP, SSH and HTTPS*. To restrict access to specific hosts see *Chapter 5 - Security, Restrict Access - Telnet, SSH and SNMP*.

# Chapter Seven

## Network Time Protocol (NTP)

*This chapter describes how to configure the RTM3205 NTP Server. It also includes brief instruction for setting up NTP Clients on your Unix-like or Windows platform. This manual is not a 'How-To' on installing and using NTP. Only basic approaches to NTP client configuration for operation with RTM3205 will be described. If you have never used NTP, then you should spend some time reading the on-line documents, especially the Distribution Notes, FAQ and Configuration subject matter, which are available at:*

*For Linux:*

[nwttime.org/documentationandlinks/](http://nwttime.org/documentationandlinks/)

*or for Windows:*

[docs.microsoft.com/en-us/windows-server/networking/windows-time-service/windows-time-service-top](https://docs.microsoft.com/en-us/windows-server/networking/windows-time-service/windows-time-service-top)

*A simple introduction to NTP is here:*

[endruntechnologies.com/pdf/NTP-Intro.pdf](http://endruntechnologies.com/pdf/NTP-Intro.pdf)

### Configuring the NTP Server

#### Configuring the RTM3205 as a Stratum 1 Server

To configure your RTM3205 as a Stratum 1 NTP Server you must have successfully completed the Basic Installation procedures in Chapter 2. By default, RTM3205 is configured to respond to NTP requests from clients that may or may not be using MD5 authentication. If the clients are using MD5 authentication, they must be configured properly with the same MD5 authentication keys as RTM3205. If you need to modify the factory default RTM3205 MD5 keys (recommended) or set up broadcast/multicast operation, then you will need to reconfigure the NTP subsystem. You may perform the configuration from either a **telnet** or **ssh** session or the local RS-232 console.

#### NOTE

If you would like to configure your server for multicast operation, configure it as you would for broadcast operation, with the exception that you must enter this specific NTP IPV4 multicast address: 224.0.1.1, or this specific IPV6 multicast address ff05::101, when you are prompted to enter the broadcast address.

**Configuring NTP Using the Network Interface or Serial Port**

The following shows the question and answer configuration utility called `ntpconfig`. The user-entered responses are shown in a larger font size.

```
RTM3205(root@RTM3205:~)-> ntpconfig
```

```
*****
*****Network Time Protocol Configuration*****
*****
*
* This script will allow you to configure the ntp.conf and ntp.keys files *
* that control RTM3205 NTP daemon operation. *
*
* You will be able to create new MD5 authentication keys which are stored *
* in the ntp.keys file. *
*
* You will be able to update the authentication related commands in the *
* ntp.conf file. *
*
* You will be able to configure the "broadcast" mode of operation, with *
* or without authentication. If you supply the multicast address instead *
* of your network broadcast address, then you will be able to configure *
* the time-to-live of the multicast packets. *
*
* The changes you make now will not take effect until you re-boot the *
* RTM3205. If you make a mistake, just re-run ntpconfig prior to *
* re-booting. *
*
* You will now be prompted for the necessary set up parameters. *
*
*****
*****
```

```
---MD5 Keyfile Configuration
```

```
Would you like to create a new ntp.keys file? ([y]es, [n]o) Y
```

You will be prompted for a key number (1 - 65534), then the actual key.  
When you have entered all of the keys that you need, enter zero at the next  
prompt for a key number.

MD5 keys may contain from 1 to 31 ASCII characters. They may not contain  
contain SPACE, TAB, LF, NULL, or # characters! If the key is longer than  
20 characters, then only the valid hexadecimal characters  
(0 - 9, a, b, c, d, e, f) may be used.

```
Enter a key number (1-65534) or 0 to quit: 1
```

```
Enter the key (1-31 ASCII characters): EndRun_Technologies
```

```
Writing key number: 1 and Key: EndRun_Technologies to ntp.keys
```

```
Enter a key number (1-65534) or 0 to quit: 2
```

```
Enter the key (1-31 ASCII characters): RTM3205
```

```
Writing key number: 2 and Key: RTM3205 to ntp.keys
```



---

## NETWORK TIME PROTOCOL (NTP)

Enter a key number (1-65534) or 0 to quit: 0

### ---NTP Authentication Configuration

Do you want authentication enabled using some or all of the keys in the ntp.keys file? ([y]es, [n]o) Y

You will be prompted for the key numbers (1 - 65534), that you want NTP to "trust". The key numbers you enter must exist in your ntp.keys file. If you do not want to use some of the keys in your ntp.keys file, do not enter them here. NTP will treat those keys as "untrusted".

Clients that use any of the "trusted" keys in their NTP polling packets will receive authenticated replies from the RTM3205. When you have entered all of the "trusted keys" that you need, enter zero at the next prompt for a key number.

Enter a trusted key number (1-65534) or 0 to quit: 1

Enter a trusted key number (1-65534) or 0 to quit: 2

Enter a trusted key number (1-65534) or 0 to quit: 0

### ---NTP Broadcast/Multicast Configuration

Would you like to enable broadcast/multicast server operation? ([y]es, [n]o) Y

Set the network broadcast/multicast address for the RTM3205 to use. For broadcast mode on IPV4 networks, this address is the all 1's address on the sub-net.

Example: 111.112.113.255

On IPV6 networks, there is more than one way to define a range of multicast addresses:

Example: ff05::1 (all nodes on the local site)

Example: ff02::1 (all nodes on the local link)

There are specific multicast addresses assigned for NTP Operation:

For IPV4 multicast operation, it is this specific address-> 224.0.1.1

For IPV6 multicast operation, it is this specific site scope address-> ff05::101

Enter IP address for NTP broadcast/multicast operation (aaa.bbb.ccc.ddd or aaaa::bbbb ): 224.0.1.1

You have selected multicast operation. Enter the TTL value that is needed for multicast packets on your network (1, 32, 64, 96, 128, 160, 192, 224): 32

It is highly recommended that authentication be used if you are using NTP in broadcast/multicast mode. Otherwise clients may easily be "spoofed" by a fake NTP server. You can specify an MD5 key number that the RTM3205 will use in its broadcast/multicast packets. The clients on your network must be configured to use the same key.

Would you like to specify an MD5 key number to use with broadcast/multicast mode? ([y]es, [n]o) Y

Enter the MD5 key number to use (1-65534): 2

```

*****
*****
*
*   The RTM3205 Network Time Protocol configuration has been updated.
*
*
*           Please re-boot now for the changes to take effect.
*
*
*****
*****
*****

```

### Configuring the RTM3205 as a Stratum 2 Server

Operating RTM3205 as a Stratum 1 Server is the recommended mode. However, there are times when Stratum 2 operation is a good strategy:

1. When you want a backup source of time. In this case, RTM3205 will operate as a Stratum 1 Server as long as it is locked to the GPS signal. If it loses the signal, then RTM3205 will start to drift away from “perfect” time. Eventually, when it has drifted 10 milliseconds, it reach the unlocked condition and stop serving time on your network. If you have RTM3205 configured for Stratum 2 operation, then it will continue serving time, using another Time Server as its reference. If RTM3205 is later able to acquire lock on the GPS signal again, it will switch back to Stratum 1 operation.

2. When you want your RTM3205 to serve accurate time, but you don’t want to use the antenna (for some reason). In this case, RTM3205 can operate solely as a Stratum 2 server, with no antenna connected.

Since there are innumerable ways to configure your network with Stratum 2 servers, specific instructions for how to do that are beyond the scope of this manual. General instructions on how to edit the *ntp.conf* file are below.

#### Edit *ntp.conf* File

You must edit the *ntp.conf* file in order to point your Stratum 2 server at a Stratum 1 server. Edit */etc/ntp.conf* and add your server line(s). (See *Appendix C - Helpful Linux Information* for information on a simple editor.) Here is an example:

```
server 192.168.1.1
```

Or, if you have set up a domain name server via **netconfig**, here is another example:

```
server your.timeserver.com
```

#### IMPORTANT

Do not remove the server lines for the refclock. Even if your Time Server is not connected to an antenna, the refclock server lines must remain.

Now save the edited file and copy it to the non-volatile flash partition with this command:

```
cp -p /etc/ntp.conf /boot/etc
```

### Mask Alarm

In Stratum 1 operation an alarm will be indicated when there is a loss of signal or if the antenna is not connected. For Stratum 2 operation you may not want to see these alarms. You can mask them (prevent them from showing) by using the console port (serial/network) commands `setsigfltmask` and `setantfltmask`.

## Setting Up NTP Clients on Unix-like Platforms

To configure your Unix-like computer to use your RTM3205, you must have successfully completed the NTP Server basic installation procedure described above. It is expected that you are, or have access to, a capable Unix/Linux system administrator and know more than a little about installing distributions from source code. Installation must be performed by a user with root privileges on the system.

If you have access to a usenet news server, many problems may be solved by the helpful people who participate in the Internet news group devoted to NTP at *comp.protocols.time.ntp*.

Three methods of using RTM3205 with NTP clients on Unix-like platforms will be described:

**Basic:** This is the simplest, and will operate without MD5 authentication. **NTP beginners should always perform this setup first.**

**MD5:** This method is trickier only because MD5 keys must be set up and distributed accurately to the NTP clients in a secure way. RTM3205 is factory configured to authenticate its replies to NTP MD5 clients using its default set of keys.

**Broadcast/Multicast:** This method simplifies configuration of the clients on large networks since specific server addresses need not be configured in each client's */etc/ntp.conf* file. It can be configured either with or without MD5 authentication. However, it is highly recommended that authentication be configured when using broadcast/multicast mode due to the relative ease with which a fake NTP server can take over the clock setting of the broadcast/multicast clients on the network.

### Unix-like Platforms: Basic NTP Client Setup

Basic setup is relatively simple, if:

- You have been able to successfully communicate with RTM3205 on your network.
- You have installed NTP on your client computer.

**Configure NTP**

You must edit the *ntp.conf* file which **ntpd**, the NTP daemon, looks for by default in the */etc* directory. Add this line to the *ntp.conf* file:

```
server 192.168.1.120
```

This line tells **ntpd** to use the NTP server at address 192.168.1.120 in addition to any other servers which might also be configured in the client's *ntp.conf* file.

Restart **ntpd** to have it begin using RTM3205. Use the NTP utility **ntpq** to check that **ntpd** is able to communicate with RTM3205. After issuing the command

```
ntpq
```

you will see the **ntpq** command prompt:

```
ntpq>
```

Use the command

```
peers
```

to display the NTP peers which your computer is using. One of them should be the RTM3205 server which you have just configured. You should verify that it is being 'reached'. (You may have to continue issuing the **peers** command for a minute or two before you will see the 'reach' count increment.) If you have other peers configured, verify that the offset information for the RTM3205 server peer and your other peers is in agreement to within a few milliseconds, assuming that the other peers are synchronized to that level of accuracy.

It may also be useful to start the NTP daemon in 'debug' mode (**ntpd -d**) to confirm successful configuration. Refer to the NTP documentation for detailed usage of these debug utilities.

**Unix-like Platforms: MD5 Authenticated NTP Client Setup**

MD5 authenticated setup is relatively simple, if:

- You have been able to successfully communicate with RTM3205 on your network.
- Your RTM3205 has been configured to perform authentication either by factory default, or by running the **ntpconfig** shell script. The example RTM3205 authentication configuration shown in *Configuring NTP Using the Network Interface or Serial Port* above, will be assumed in the example configuration commands shown here.
- You have installed NTP on your client computer.
- You have successfully performed the *Unix-like Platforms: Basic NTP Client Setup* on your client computer.

**Create the `ntp.keys` File**

You must create a file named `ntp.keys` in the `/etc` directory. It must be a copy of the one residing in the `/etc` directory of your RTM3205. You can **telnet** into your RTM3205 and start an **ftp** session with your client computer to send the RTM3205's `/etc/ntp.keys` file to your client computer, use the secure copy utility **scp**, or you can just use a text editor on your client computer to create an equivalent file.

**IMPORTANT**

Handling of the `/etc/ntp.keys` file is the weak link in the MD5 authentication scheme. It is very important that it is owned by **root** and not readable by anyone other than **root**.

After transferring the file by **ftp**, and placing it in the `/etc` directory on the client computer, issue these two commands at the shell prompt:

```
chown root.root /etc/ntp.keys
chmod 600 /etc/ntp.keys
```

**Configure NTP**

You must edit the `ntp.conf` file which **ntpd**, the NTP daemon, looks for by default in the `/etc` directory. Assuming that you have created two trusted keys as shown in *Configuring the NTP Server Using the Network Interface or Serial Port* above, add these lines to the end of the `ntp.conf` file:

```
keys /etc/ntp.keys
trustedkey 1 2
```

Modify the line added previously in *Unix-like Platforms: Basic NTP Client Setup* so that authentication will be used with the RTM3205 server using one of the trusted keys, in this example, key # 1:

```
server 192.168.1.120 key 1
```

Restart **ntpd** to have it begin using the RTM3205 server with MD5 authentication. Use the NTP utility **ntpq** to check that **ntpd** is able to communicate with RTM3205. After issuing the command

```
ntpq
```

you will see the **ntpq** command prompt:

```
ntpq>
```

Use the command

```
peers
```

to display the NTP peers which your computer is using. One of them should be the RTM3205 server which you have just configured. You should verify that it is being 'reached'. (You may have to continue issuing the `peers` command for a minute or two before you will see the 'reach' count increment.) You can verify that authentication is being used by issuing the command

**associations**

to display the characteristics of the client server associations. In the “auth” column of the display, you should see “OK” for the row corresponding to the RTM3205 server. If you see “bad”, you should wait a few minutes to be sure that there is a problem since “bad” is the initial state of this setting. If the “bad” indication persists then you must check your configuration for errors. Typically this is due to a typing error in creating the `/etc/ntp.keys` file on the client that causes a mismatch between the keys being used by the server and client. (If you transfer the file by `ftp` or `scp`, this shouldn’t be a problem.) It is also possible to have a typing error in the `/etc/ntp.conf` file that causes the needed key to not be included in the “trustedkey” list.

**Unix-like Platforms: Broadcast/Multicast NTP Client Setup**

Broadcast/multicast client setup is relatively simple, if:

- You have been able to successfully communicate with RTM3205 on your network.
- Your RTM3205 has been configured to perform broadcasts or multicasts by running the `ntpconfig` shell script. (This is not the factory default configuration, so be sure to run `ntpconfig`.) If you are going to use MD5 authentication, your RTM3205 must have been configured to operate with authentication in the broadcast/multicast mode, and you must know which of the trusted keys it is using for broadcast/multicast operation. The example RTM3205 configuration shown in *Configuring the NTP Server* above will be assumed in the example configuration commands shown here.
- You have installed NTP on your client computer.
- You have successfully performed the *Unix-like Platforms: MD5 Authenticated NTP Client Setup* on your client computer, if you plan to use MD5 authentication.

**Configure NTP Client for Broadcast**

You must edit the `ntp.conf` file which `ntpd`, the NTP daemon, looks for by default in the `/etc` directory. Assuming that your RTM3205 server has been configured to use key 2 for broadcast authentication as shown in the example in *Configuring the NTP Server* above, make sure that key 2 is included in the `trustedkey` line, and add this line to the end of the `ntp.conf` file:

```
broadcastclient
```

If you are not using MD5 authentication, you would add these lines:

```
disable auth  
broadcastclient
```

You may remove the line added previously in *Unix-like Platforms: Basic NTP Client Setup*:

```
server 192.168.1.120
```

or the authenticated version added in *Unix-like Platforms: MD5 Authenticated NTP Client Setup*:

```
server 192.168.1.120 key 1
```

**Configure NTP Client for Multicast**

You must edit the *ntp.conf* file which **ntpd**, the NTP daemon, looks for by default in the the */etc* directory. And add these lines for multicast:

```
multicastclient 224.0.1.1
```

or for IPv6:

```
multicastclient ff05::101
```

If you are not using MD5 authentication, you would add these lines:

```
disable auth  
multicastclient 224.0.1.1
```

or for IPv6:

```
disable auth  
multicastclient ff05::101
```

You may remove the line added previously in *Unix-like Platforms: Basic NTP Client Setup*:

```
server 192.168.1.120
```

or the authenticated version added in *Unix-like Platforms: MD5 Authenticated NTP Client Setup*:

```
server 192.168.1.120 key 1
```

**Test Broadcast/Multicast**

Restart **ntpd** to have it begin using RTM3205 as a broadcast or multicast server. Use the NTP utility **ntpq** to check that **ntpd** is able to communicate with RTM3205. After issuing the command

```
ntpq
```

you will see the **ntpq** command prompt:

```
ntpq>
```

Use the command

```
peers
```

to display the NTP peers which your computer is using. One of them should be the RTM3205 server which you have just configured. You should verify that it is being 'reached'. (You may have to continue issuing the **peers** command for a minute or two before you will see the 'reach' count increment.)

If you are using authentication, you can verify that authentication is being used by issuing the command

```
associations
```

to display the characteristics of the client server associations. In the “auth” column of the display, you should see “OK” for the row corresponding to the RTM3205 server. If you see “bad”, you should wait a few minutes to be sure that there is a problem since “bad” is the initial state of this setting. If the “bad” indication persists then you must check your configuration for errors. Typically this is due to a typing error in creating the `/etc/ntp.keys` file on the client that causes a mismatch between the keys being used by the server and client. (If you transfer the file by `ftp` or `scp`, this shouldn’t be a problem.) It is also possible to have a typing error in the `/etc/ntp.conf` file that causes the needed key to not be included in the “trustedkey” list.

## Setting Up NTP Clients on Windows

To configure your Windows computer to use your RTM3205, you must have successfully completed the procedures in *Configuring the NTP Server* above. Client installation must be performed by a user with administrative privileges.

If you have access to a usenet news server, many problems may be solved by the helpful people who participate in the Internet news group devoted to NTP at [comp.protocols.time.ntp](mailto:comp.protocols.time.ntp).

The most common NTP client on Windows platforms is described below. Information on other NTP Client software is available at:

[endruntechnologies.com/products/ntp-time-servers/ntp-client-software](http://endruntechnologies.com/products/ntp-time-servers/ntp-client-software)

### Windows: W32Time

Windows uses a time service called W32Time which is automatically enabled by default during Windows installation. `w32tm.exe` synchronizes time in different ways, depending on the network implementation used. When peer-to-peer networking is used, then each individual workstation synchronizes to the NTP Server. For details, copy and paste this into your browser:

[docs.microsoft.com/en-us/windows-server/networking/windows-time-service/windows-time-service-tools-and-settings](http://docs.microsoft.com/en-us/windows-server/networking/windows-time-service/windows-time-service-tools-and-settings)

However, the most common method is with Windows Domain Networking. In this case, you must configure the Primary Domain Controller (PDC) to synchronize to the NTP Server. All other servers and workstations in the domain synchronize to the PDC. The default Windows installation procedure automatically configures workstations and servers to synchronize to the controlling PDC. So, only the PDC needs to be configured to synchronize to the NTP Server.

## Security

For Unix-like platforms you can configure your NTP clients for secure MD5 authentication. See *Unix-like Platforms: MD5 Authenticated NTP Client Setup*. You can also restrict NTP query access - see below.



### Restrict NTP Query Access

The Network Time Protocol (NTP) implementation in RTM3205 is built from the reference distribution at:

[nwttime.org/downloads/](http://nwttime.org/downloads/)

By factory default, remote control and query of the NTP daemon **ntpd** is disabled. Query-only operation is supported only from processes running on RTM3205 itself, i.e. from the *localhost*. This restricts access to **ntpd** from remote hosts using either of the two NTP companion utilities **ntpq** and **ntpdc**.

Control via these two utilities is disabled in the */etc/ntp.conf* file in two ways. First, MD5 authentication keys are not defined for control operation via a *requestkey* or *controlkey* declaration. Second, this default address restriction line is present in the file:

```
restrict default nomodify noquery nopeer
restrict 127.0.0.1 nomodify
restrict 0:::1 nomodify
```

The first line eliminates control and query access from ALL hosts. The second and third lines disable the localhost from making any modifications to the **ntpd** daemon, but query access is not affected by this restriction. These lines must not be removed, as they are necessary for various monitoring processes running on RTM3205 to function properly.

Knowledgeable NTP users who would like to customize the security aspects of the configuration of the NTP daemon in RTM3205 should edit the */etc/ntp.conf* file directly and then copy it to the */boot/etc* directory. Be sure to retain the ownership and permissions of the original file by using **cp -p** when performing the copy.

#### CAUTION

If you are planning to make changes to the */etc/ntp.conf* file, you must NOT restrict query access from the local host to the NTP daemon. Various system monitoring processes running on the system require this access.

An example follows which shows how to allow query access from a specific remote host with IP address 192.168.1.10 while also allowing processes running on RTM3205 to have query access as well:

```
restrict default noquery nomodify nopeer
restrict 127.0.0.1 nomodify
restrict 0:::1 nomodify
restrict 192.168.1.10 nomodify
```

This page intentionally left blank.

# Chapter Eight

## IPv6 Information

*The RTM3205 Precision Timing Module supports IPv6 out-of-the-box with a modern version 3.2.2 Linux kernel. During network configuration, you have the option to disable IPv6 on either or both Ethernet ports. The IPv6 addressing scheme will see expanding deployment in the near future due to the fact that there are no longer any IPV4 addresses to be allocated in many regions of the world.*

### IPv6 Capabilities

The presence of an IPv6-capable kernel will automatically enable most of the IPv6 capabilities. By default, autoconfiguration of the Ethernet interfaces via IPv6 Router Advertisements is enabled. To disable acceptance of Router Advertisements, or to configure a static IPv6 address and default IPv6 gateway, and to configure IPv6 domain name servers, you must run the interactive **netconfig** script. This will allow you to configure your Ethernet interface for both IPv4 and IPv6 operation. You can also configure the hostname and domainname for the unit.

### OpenSSH

By default, **sshd** is factory-configured to listen on both IPv4 and IPv6 addresses. It may be forced to listen on either IPv4 only, or IPv6 only by editing the `/etc/ssh/sshd_config` file and modifying the **AddressFamily** directive, and then copying it to `/boot/etc/ssh`. Refer to the `sshd_config` man page for detailed information (**man sshd\_config**).

### Apache HTTP

By default, **httpd** is factory-configured to listen on both IPv4 and IPv6 addresses. It may be forced to listen on either IPv4 only, or IPv6 only by editing the `/etc/httpd/httpd.conf` configuration file and adding a **Listen** directive, and then copying it to `/boot/etc/httpd`. Refer to the Apache HTTP documentation for details.

### Net-SNMP

By default, **snmpd** is factory-configured to listen on both IPv4 and IPv6 addresses. This may be changed by editing `/etc/rc.d/rc.snmpd` and modifying the agent address argument passed to **snmpd** at start-up, and then copying it to `/boot/etc/rc.d`.

**NTP**

By default, **ntpd** is factory-configured to listen on both IPv4 and IPv6 addresses on all interfaces. This may be changed by editing */etc/ntp.conf* and adding the desired **interface** directives to achieve the desired behavior, and then copying it to */boot/etc*. For example, adding this line:

```
interface ignore ipv6
```

will cause **ntpd** to not bind to any IPv6 addresses. Refer to the NTP documentation for details on the **interface** directive.

**IPv4-Only Protocols**

There are several protocols running on RTM3205 which are not IPv6 capable: **telnet** (client and server), **ftp** and **dhcpcd**. Due to their intrinsic insecurity, **telnet** and **ftp** are rapidly being deprecated, and probably have little business running over an IPv6 network. The address autoconfiguration capabilities of IPv6 along with the Neighbor Discovery Protocol (NDP) make the DHCP protocol less important in IPv6 networks. The optional PTP/IEEE-1588 protocol is also not available on IPv6.

# Chapter Nine

## Optional Precision Time Protocol (PTP/IEEE-1588)

This chapter contains the configuration and status information for the optional Precision Time Protocol. PTP version 2 is supported. The PTP protocol running on RTM3205 is a full Grandmaster Clock (default profile) implementation of the IEEE-1588-2008 standard.

### Software Option

The PTP/IEEE-1588 protocol is an optional feature in the RTM3205. Read *Appendix I - Software Options* if you need information on how to install a software option. To see whether this option is installed on your RTM3205, use the `installed_sw_opts` command:

```
Command:    installed_sw_opts
RTM3205 reply: <no reply>
```

In this case, there is no PTP option installed. Contact EndRun Technologies if you would like to obtain PTP for one or both ports. In the case below, PTP is installed on both ports.

```
Command:    installed_sw_opts
RTM3205 reply: The PTP0 Daemon Option is Installed.
               The PTP1 Daemon Option is Installed.
```

### About PTP

The PTP implementation in RTM3205 is based on the distribution at the PTPd website:

<http://ptpd.sourceforge.net>

For more information about the `ptpd` daemon and to obtain PTP Slave software, refer to the PTPd website. When downloading PTP Slave software from the PTPd website, be sure to obtain this version: `ptpd-2.2.2.tar.gz`.

An excellent book which describes the PTP Master and Slave operation is:

*Measurement, Control, and Communication using IEEE 1588*,  
John C. Eidson, Springer, November 2006.

More information on IEEE-1588 PTP can be found at the NIST National Institute of Standards and Technology IEEE 1588 website:

<http://www.nist.gov/el/isd/ieee/ieee1588.cfm>

## Two Gigabit Ports

The PTP daemon status and configuration is supported from two PTP companion utilities **ptpstatx** and **ptpconfigx**, where x is network port 0 (**eth0**) or 1 (**eth1**). The following table shows RTM3205 utilities that pertain to PTP:

	Daemon	Status	Configuration
PTP	<b>ptpd0</b> <b>ptpd1</b>	<b>ptpstat0</b> <b>ptpstat1</b>	<b>ptpconfig0</b> <b>ptpconfig1</b>

PTP can be enabled on one or both network ports (**eth0** and **eth1**). If PTP is enabled on only one port, then **eth0** is the network port identifier and you would use **ptpstat0** and **ptpconfig0** for PTP status and configuration. If PTP is enabled on both ports, then both **eth0** and **eth1** will be used.

## PTP Configuration and Status

If the PTP/IEEE-1588 Option is installed in your Tycho, then you can configure PTP and get status information via the command line interface. To confirm whether this option is installed, enter the following command:

```
Command:    installed_sw_opts
RTM3205 reply: The PTP0 Daemon Option is Installed. (PTP installed on port 0 only.)
or
RTM3205 reply: The PTP0 Daemon Option is Installed. (PTP installed on both ports.)
               The PTP1 Daemon Option is Installed.
```

Read *Appendix I - Software Options* if you need information on how to install a software option.

### Default PTP Configuration Settings

The default PTP configuration settings in RTM3205 are shown below. If you need to modify these settings then you will need to reconfigure the PTP Subsystem. Default PTP settings are:

	Port 0 (eth0)	Port 1 (eth1)
Sync Interval	1 second	1 second
Announce Inverval	2 seconds	2 seconds
Priority 1	128	128
Priority 2	128	128
Delay Mechanism	E2E	E2E
Domain	0	1
PTP Time Mode	PTP	PTP
PTP TTL	1	1
Transmission Mode	Multicast	Multicast

## PTP Configuration Using the Network or Serial Port

The `ptpconfig0` or `ptpconfig1` command starts an interactive shell script that will allow you to configure the PTP Subsystem of RTM3205. You will be prompted to set PTP parameters as follows:

```

ETH Port:                0 or 1
Sync Interval (Per Second): 1, 2, 4, 8, 16, 32, 64, 128
Announce Interval (Seconds): 1, 2, 4, 8, or 16
Priority1:                0-255
Priority2:                0-255
Delay Mechanism:         E2E or P2P
Domain:                  0-255
PTP Time Mode:           UTC or PTP
PTP TTL:                 1-255
Transmission Mode        Multicast or Hybrid

```

One file is modified for each port. Either `/etc/ptp0.conf` for `eth0` or `/etc/ptp1.conf` for `eth1`. These are non-volatile files stored in the FLASH disk `/boot/etc` directory. You must reboot RTM3205 after running this script for the changes to take effect.

The following is a transcript of the question and answer configuration utility provided by `ptpconfig0` or `ptpconfig1`. The user-entered parameters are underlined:

```

RTM3205(root@host~)-> ptpconfig0
*****
*****Precision Time Protocol IEEE-1588 V2 Configuration*****
*****
*
* This interactive utility will guide you in configuring the ptp daemon
* configuration file that controls its operation on port 0.
*
* You will be able to configure the PTP sync interval, announce interval,
* priority1, priority2, delay mechanism , ptp domain, time mode and
* time-to-live (TTL).
*
* The changes you make now will not take effect until you re-boot.
* If you make a mistake, just re-run ptpconfig0 prior to
* re-booting.
*
* You will now be prompted for the necessary set up parameters.
*
*****
---PTP Sync Interval Configuration

Set the PTP Sync Interval in packets per second (1, 2, 4, 8, 16, 32, 64, 128) 1

---PTP announce interval Configuration

Set the PTP Announce Interval in seconds (1, 2, 4, 8, 16) 16

---PTP Priority1 Configuration

Set the PTP Priority1 value (0-255) 127

---PTP Priority2 Configuration

```

---

## CHAPTER NINE

```
Set the PTP Priority2 value (0-255) 128

---PTP Delay Mechanism E2E or P2P

Set the PTP Delay Mechanism (E2E or P2P) P2P

---PTP Domain Configuration

Set the PTP Domain value (0-255) 0

---PTP Time Mode Configuration

Set the PTP Time Mode (UTC or PTP) PTP

---PTP TTL Configuration

Set the PTP TTL value (1-255) 1

Set the PTP Transmission Mode (Multicast or Hybrid) Multicast

*****
*****
*
*   The Precision Time Protocol IEEE-1588 V2 configuration has been updated.
*
*           Please re-boot now for the changes to take effect.
*
*****
*****
*****
```

Now reboot the system by issuing this command at the shell prompt:

```
reboot
```

### PTP Status Using the Network or Serial Port

The `ptpstat0` or `ptpstat1` command allows you to query the status of the PTP Subsystem. Following is the response to this command:

```
V SI AI P1 P2 DM DOM MODE TTL CLASS SCALE STATE CLKID UTC UTCV CA L59 L61 TT FT TM
```

Where:

- V is the IEEE-1588 version 2 for the 2008 standard.
- SI is the PTP sync interval either 1, 1/2, 1/4, 1/8, 1/16, 1/32, 1/64, or 1/128 seconds.
- AI is the PTP announce interval, either 1, 2, 4, 8, or 16 seconds.
- P1 is the PTP priority 1 in a range from 0 to 255.
- P2 is the PTP priority 2 in a range from 0 to 255.
- DM is the PTP delay mechanism, either E2E or P2P.
- DOM is the PTP domain, in a range from 0 to 255.



MODE	is the PTP time mode, either UTC or PTP.
TTL	is the PTP multicast time-to-live in a range from 1 to 255.
CLASS	is the PTP clock class one of SYNCHRONIZED, HOLDOVER, or UNLOCKED.
SCALE	is the PTP timescale either PTP or ARB.
STATE	is the PTP port state one of MASTER, PASSIVE, LISTENING or INITIALIZING.
CLKID	is the PTP clock source either GPS or OSC.
UTC	is the PTP utc offset in seconds from TAI.
UTCV	is the PTP utc offset valid, either TRUE or FALSE.
CA	is the PTP clock accuracy one of 25ns, 100ns, 250ns, 1us, 2.5us, 10us, 25us, 100us, 250us, 1ms, 2.5ms, 10ms, or Unknown.
L59	is the PTP leap 59 second indicator, either TRUE or FALSE.
L61	is the PTP leap 61 second indicator, either TRUE or FALSE.
TT	is the PTP time traceable indicator, either TRUE or FALSE.
FT	is the PTP frequency traceable indicator, either TRUE or FALSE.
TM	is the PTP transmission mode, either MULTICAST or HYBRID

## PTP Operation

The RTM3205 is configured as an IEEE-1588 Grandmaster Clock (default profile). Verify that the network settings have been configured and tested using **netconfig**. Once the network has been configured, the RTM3205 will begin to transmit PTP Sync messages after it is locked.

The PTP Sync Interval is user configured. 1, 2, 4, 8, 16, 32, 64, or 128 packets per second are transmitted as a multicast. The packets are only transmitted when the clock is fully synchronized or in holdover with a known clock accuracy.

The PTP Announce Interval is user configured. Packets are transmitted every 1, 2, 4, 8, or 16 seconds as a multicast. The packets are only transmitted when the clock is fully synchronized or in holdover with a known clock accuracy.

The Delay Request Interval is not user-configurable. It is set to 32 seconds.

The PTP Priority 1 is user configured in a range from 0 to 255.

The PTP Priority 2 is user configured in a range from 0 to 255.

**NOTE**

If using a single Grandmaster, keep the default setting of 128 for Priority 1 and Priority 2. If using two redundant Grandmasters, then you can configure the preferred clock by setting Priority 1 to 127 and Priority 2 to 128.

The PTP Delay Mechanism is user configured to either E2E or P2P. E2E uses the delay request-response mechanism and P2P uses the peer delay mechanism.

The PTP Domain is user configured in a range from 0 to 255.

The PTP Time Mode is user configured to either UTC or PTP. When UTC Time mode is configured the clock transmits the UTC epoch and sets the PTP Scale to ARB. When the Time mode is PTP the clock transmits the PTP epoch (TAI) and sets the PTP Scale to PTP. See *About the PTP Second and UTC Time* at the end of this chapter for more information.

The PTP Multicast TTL is user configured in a range from 1 to 255. For a local area network the TTL should be configured to 1.

PTP Clock Class one of SYNCHRONIZED, HOLDOVER, or UNLOCKED. The Clock Class is SYNCHRONIZED when the GPS Subsystem TFOM level is less than or equal to 4 (see *Appendix A - TFOM*). The Clock Class is HOLDOVER when the GPS Subsystem TFOM level is greater than 4 and less than 9. The Clock Class is UNLOCKED when the GPS Subsystem TFOM level is 9.

The PTP Timescale either PTP or ARB. When Time Mode is configured to PTP the clock transmits the Timescale as PTP. When the Time mode is UTC the clock transmits the Timescale as ARB. The PTP Port State is one of MASTER, PASSIVE or LISTENING. The PTP Port State is selected as MASTER by the best master clock algorithm, otherwise it is PASSIVE or LISTENING.

The PTP Clock Source is either GPS or OSC. The Clock Source is GPS if the Clock Class is Synchronized, otherwise it is OSC based on the system oscillator.

The PTP UTC Offset is the offset between TAI and UTC in units of seconds.

The PTP UTC Offset Valid is either TRUE or FALSE. The UTC Offset Valid is TRUE if the current UTC Offset is known to be correct, otherwise it is FALSE.

The PTP Clock Accuracy is transmitted when the time is accurate to within the the following:

25ns	Clock is synchronized or in holdover, PTP clock < 25 nanoseconds
100ns	Clock is synchronized or in holdover, PTP clock < 100 nanoseconds
250ns	Clock is synchronized or in holdover, PTP clock < 250 nanoseconds
1us	Clock is synchronized or in holdover, PTP clock < 1 microsecond
2.5us	Clock is synchronized or in holdover, PTP clock < 2.5 microseconds
10us	Clock is synchronized or in holdover, PTP clock < 10 microseconds
25us	Clock is synchronized or in holdover, PTP clock < 25 microseconds
100us	Clock is synchronized or in holdover, PTP clock < 100 microseconds

250us	Clock is synchronized or in holdover, PTP clock < 250 microseconds
1ms	Clock is synchronized or in holdover, PTP clock < 1 millisecond
2.5ms	Clock is synchronized or in holdover, PTP clock < 2.5 milliseconds
10ms	Clock is synchronized or in holdover, PTP clock < 10 milliseconds
Unknown	Clock is unsynchronized, TFOM = 9

The PTP Leap 59 second indicator is either TRUE or FALSE. The Leap 59 is TRUE if the PTP Timescale is PTP and the last minute of the current UTC day contains 59 seconds, otherwise it is FALSE.

The PTP Leap 61 second indicator is either TRUE or FALSE. The Leap 61 is TRUE if the PTP Timescale is PTP and the last minute of the current UTC day contains 61 seconds, otherwise it is FALSE.

The PTP Time Traceable indicator is either TRUE or FALSE. The Time Traceable is TRUE if the Time Scale is PTP and the Clock Class is Synchronized or Holdover, otherwise it is FALSE.

The PTP Frequency Traceable indicator is either TRUE or FALSE. The Frequency Traceable is TRUE if the Time Traceable is TRUE, otherwise it is FALSE.

The PTP Transmission Mode is either Multicast or Hybrid. Multicast Mode is the default and is defined in the IEEE-1588 standard. All packets sent from the Grandmaster are Multicast. Hybrid Mode uses Multicast and Unicast. In this mode, delay response messages are sent Unicast in response to the slave delay request. NOTE: Unicast messages are only sent when the Delay Mechanism is configured to E2E.

## About the PTP Second and UTC Time

The PTP Time Mode selections are PTP and UTC. The IEEE-1588 standard defines the PTP epoch beginning at 0 hours on 1 January 1970. The time measured since this epoch is designated in the standard as PTP seconds. The PTP second is monotonic so does not include leap seconds.

Unlike PTP, the UTC second is not monotonic, that is, from time-to-time there will be leap second insertions. The last second of a leap insertion day is 23:59:60 making the day one second longer than a normal day ending at 23:59:59.

### PTP Second

When the PTP Time Mode is set to PTP, the slave clocks must utilize the current leap second and leap second pending flags (leap\_59 or leap\_61) to convert the PTP second to UTC.

### UTC Time

When the PTP Time Mode is set to UTC, then there will be a one second jump in time when a leap second insertion occurs. If the PTP slave does not account for this, it will also jump. Avoid this by using PTP Time Mode.

## Multiport PTP

When only one PTP option is enabled it will be configured for **eth0** PTP Domain 0. If a second PTP option is enabled then it will be configured for **eth1** PTP Domain 1. This configuration will allow PTP to run as master on both ports.

If the PTP Domain is configured as the same value for both ports (for example, PTP Domain 0 on **eth0** and PTP Domain 0 on **eth1**) then **eth0** Port State will be master and **eth1** Port State will be listening.

## Disable the PTP Protocol

The instructions below assume that the PTP Option has been installed on Port 0 (**eth0**) of your RTM3205. To check, see the section titled *Option* at the beginning of this chapter.

To disable the Precision Time Protocol on Port 0 issue the following command:

```
chmod -x /etc/rc.d/rc.ptpd0
```

Copy the *rc.ptpd0* file to the non-volatile FLASH area like this:

```
cp -p /etc/rc.d/rc.ptpd0 /boot/etc/rc.d
```

Then:

```
reboot
```

Once PTP has been disabled, the user interface will no longer show the existence of PTP.

## Re-Enable PTP

To re-enable PTP on Port 0, remove the *rc.ptpd0* file from the */etc/rc.d* directory as shown below:

```
rm /boot/etc/rc.d/rc.ptpd0
```

Then:

```
reboot
```

### NOTE

If PTP is also installed on Port 1, then follow the instructions above using *rc.ptpd1*.

# Chapter Ten

## *Inputs/Outputs (I/O)*

*Standard configuration for RTM3205 is two Ethernet ports, antenna input, RS-232 serial port, and a DC power connector. Up to four optional time and frequency outputs can be configured.*

*Status and user settings for the output signals can be easily viewed and modified via the console port. Methods to do this are described in this chapter. Refer to **Appendix K - Specifications** for details on signals, connector types, pinouts, etc.*

### Standard I/O

#### **Antenna Jack**

This SMA connector mates with the download cable from the external antenna.

#### **Ethernet Ports**

These two RJ-45 connectors mate with the Ethernet twisted pair cable from the network. They are labeled with the corresponding MAC address and either “ETH0” or “ETH1”. Integrated LEDs indicate link speed (green) and activity (amber). The green LED will pulse once for a speed of 10M, twice for 100M, and three times for 1G. Both ports provide a console interface to RTM3205. See **Chapter 3 - Console Port Control and Status** for more information.

#### **Serial I/O Port**

This DB9M connector provides the RS-232 serial I/O console interface to RTM3205. This console allows you to initialize and maintain RTM3205. See **Chapter 3 - Console Port Control and Status** for more information. See **Appendix K - Specifications, Serial Port I/O** for pinout.

#### **DC Power Input Jack**

This 2-position jack provides connection to the DC power source. See **Chapter 2 - Basic Installation, Performing a Site Survey** for installation instructions.

### Output Options

In addition to the standard I/O described above, the RTM3205 can be configured with up to four optional outputs. These outputs are labeled SPARE if not used. The options are described below:

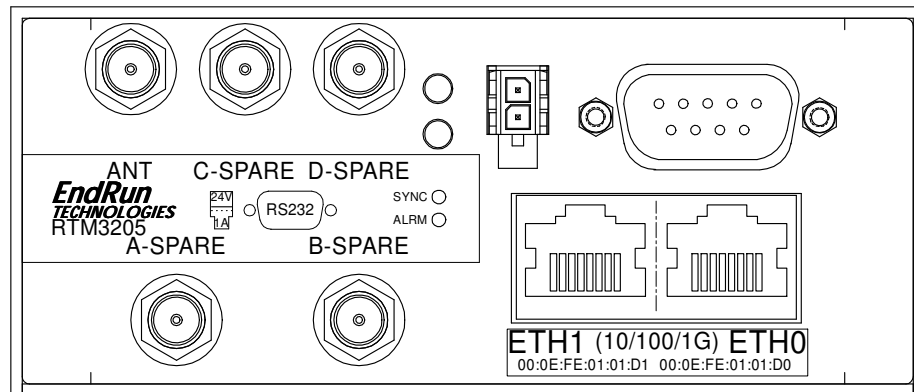

## 1 PPS Option

The 1 PPS Option is a standard TTL output. The pulse width is normally 1 millisecond wide when shipped from the factory but can be changed (see below). For details on the 1 PPS signal definition see *Appendix K - Specifications, 1 PPS Output*.

### View the 1 PPS Connector

The `cpuio` command will list any connector on the RTM3205 that has an I/O signal. Connectors are identified as A, B, C or D.

```
Command:      cpuio
RTM3205 reply: CPU I/O B - 1 PPS OUTPUT is Installed
                Current Setting = (See systemio command)
```

### Change the 1 PPS Pulse Width

Use the `systemio` command to view the 1PPS pulse width. Use the `systemioconfig` command to change the pulse width. You will be able to choose from these pulse widths: 20 microseconds, 1 millisecond, 100 milliseconds and 500 milliseconds.

```
Command:      systemio
RTM3205 reply: System I/O Signal 1 PPS OUTPUT is Installed
                Current Setting = 1 Milliseconds Pulse Width
```

```
Command:      systemioconfig
RTM3205 reply: Interactive script is started so you can change the pulse width.
```

The 1 PPS is a “system signal”. This means that there is one 1 PPS signal that affects the whole system. In other words, if your RTM3205 has multiple 1 PPS outputs and you change the pulse width, then all 1 PPS outputs will be affected.

### **Time Code Option (AM or DC)**

The Time Code Option can be either amplitude-modulated (AM) or DC-shift (DC) output. For example, these may be labeled: “A-AMCODE” (AM Time Code on connector A) or “C-DCCODE” (DC Time Code on connector C).

Time Code is a “system signal”. This means that there is one Time Code signal that affects the whole system. In other words, if your RTM3205 has multiple Time Code outputs (AM and/or DC) and you change the Time Code format, then all Time Code outputs will be affected.

The Time Code format is normally IRIG-B122 (AM) or B002 (DC) when shipped from the factory but can be changed (see below). For details on signal definition see *Appendix K - Specifications, AM Code Output* or *Appendix K - Specifications, Optional DC Code Output*.

### **View the Time Code Connector**

The `cpuio` command will list any connector on the RTM3205 that has an I/O signal. Connectors are identified as A, B, C or D.

```
Command:      cpuio
RTM3205 reply: CPU I/O A - AM TIME CODE OUTPUT is Installed
               Current Setting = (See systemio command)
```

### **Change the Time Code Format**

Use the `systemio` command to view the time code format. Use the `systemioconfig` command to change the format.

```
Command:      systemio
RTM3205 reply: System I/O Signal TIME CODE OUTPUT is Installed
               Current Setting = IRIG-B122/B002 Format
```

```
Command:      systemioconfig
RTM3205 reply: Interactive script is started so you can change the Time Code format.
```

### **Programmable Pulse Output (PPO) Option**

The PPO Option provides user-selectable, on-time pulse rates from 1 PPS to 10 MPPS. Other selections are 1PP60S (pulse per 60 seconds, on the minute), 1PP2S (pulse per 2 seconds, on the even second), and Inverted 1 PPS (falling edge on-time). For details on signal definition see *Appendix K - Specifications, Optional Programmable Pulse Output*.

### **View and Change the PPO**

The `cpuio` command will list any connector on the RTM3205 that has an I/O signal. Connectors are identified as A, B, C or D. The `cpuioconfig` command will allow you to change the pulse rate selection.

Command: **cpuio**  
RTM3205 reply: **PROGRAMMABLE PULSE OUTPUT is Installed**  
**Current Setting = OFF**

Command: **cpuioconfig**  
RTM3205 reply: Interactive script is started so you can change the pulse rate.

### **Trigger PPO Function**

When the PPO option is installed on the CPU Module, then the **triggerppo** command is available via the console port. (The trigger PPO function is not available on option modules.) The **triggerppo** is used to generate an on-time pulse via the PPO BNC. Multiple instances of this command can be running for different pulse output times, allowing scheduling of multiple triggers.

The format of the command is:

```
triggerppo = X hh:mm:ss<CR>
```

Where:

X is the CPU I/O port of the PPO Option BNC (A,B,C or D).

hh:mm:ss is the UTC time-of-day for the trigger, with 1 second resolution.

<CR> is the ASCII carriage return character (0x0D).

An example is shown here:

Command: **triggerppo = A 13:50:00** This will cause a pulse on BNC A at  
RTM3205 reply: **OK** UTC time-of-day 13:50:00.

### **Trigger PPO Specifications**

Rising edge on time, aligned with the desired second.

Accuracy < 10 nanoseconds RMS to UTC(USNO) when locked.

Pulse width mimics the standard 1PPS Output pulse width (20 us, 1 ms, 100 ms, or 500 ms).

Multiple trigger times must be at least 2 seconds apart.

Other PPO specifications are in *Appendix K - Specifications, Optional Programmable Pulse Output*.

### **Trigger PPO Operational Details**

The **triggerppo** monitors the system time and compares it to the trigger time passed to it via the console port interface. When the system time is about 1/2 second before the trigger time, then the PPO is armed so that a single pulse occurs at the next second mark. When the system time is about a 1/2 second after the trigger time, then the PPO is disarmed. For other details, at the console port type:

```
help triggerppo
```



### **Direct Digital Synthesizer (DDS) Option**

The DDS Option provides user-selectable pulse rates from 1 Hz to 10 MHz, programmable in 1 PPS steps, including 1.544 MPPS or 2.048 MPPS. The selected pulse rate is phase locked to the system oscillator and is not aligned with system time.

The DDS is a “system signal”. This means that there is one DDS signal that affects the whole system. In other words, if your RTM3205 has multiple DDS outputs and you change the pulse rate, then all DDS outputs will be affected.

The pulse rate is 0 Hz when shipped from the factory but can be changed (see below). For details on the DDS signal definition see *Appendix K - Specifications, Optional Direct Digital Synthesizer (DDS) Output*.

#### **View the DDS Connector**

The `cpuio` command will list any connector on the RTM3205 that has an I/O signal. Connectors are identified as A, B, C or D.

```
Command:      cpuio
RTM3205 reply: CPU I/O C - DIRECT DIGITAL SYNTHESIZER OUTPUT is Installed
                Current Setting = (See systemio command)
```

#### **Change the DDS Rate**

Use the `systemio` command to view the current rate setting. Use the `systemioconfig` command to change the setting.

```
Command:      systemio
RTM3205 reply: System I/O Signal DIRECT DIGITAL SYNTHESIZER OUTPUT Installed
                Current Setting = 0 Hz
```

```
Command:      systemioconfig
RTM3205 reply: Interactive script is started so you can change the pulse rate.
```

### **10 MPPS Option**

The 10 MPPS Rate Output Option provides an on-time pulse rate. For details on signal definition see *Appendix K - Specifications, Optional 10 MPPS Output*.

#### **View the 10 MPPS Output Connector**

The `cpuio` command will list any connector on the RTM3205 that has an I/O signal. Connectors are identified as A, B, C or D.

```
Command:      cpuio
RTM3205 reply: CPU I/O C - 10 MPPS OUTPUT is Installed
```

### Alarm Option

The Alarm Option provides an open-collector output that indicates when the GPS Subsystem has lost lock, or when serious hardware faults are detected. For a detailed description of the faults see *Appendix G - System Faults*.

Care should be taken not to directly connect this open-collector output to a voltage source. A series current-limiting resistor of at least 1k ohms in value should be used. The pull-up voltage must not exceed 40V. For more details see *Appendix K - Specifications, Optional Alarm Output*.

#### View the Alarm Output Connector

The `cpuio` command will list any connector on the RTM3205 that has an I/O signal. Connectors are identified as A, B, C or D.

```
Command:      cpuio
RTM3205 reply: CPU I/O C - OPEN COLLECTOR ALARM OUTPUT is Installed
```

### 10 MHz Low-Phase-Noise Option

The RTM3205 can provide one or two 10 MHz sine wave outputs with very low phase noise. For details see *Appendix K - Specifications, Optional 10 MHz LPN Output*.

#### View the 10 MHz Connector

The `cpuio` command will list any connector on the RTM3205 that has an I/O signal. Connectors are identified as A, B, C or D.

```
Command:      cpuio
RTM3205 reply: CPU I/O C - 10MHz LOW PHASE NOISE OUTPUT is Installed
```

# Chapter *Eleven*

## *Real-Time Ionospheric Corrections (RTIC) Option*

*This chapter describes the RTIC Option, its operation, and the time and frequency performance benefits to RTM3205. Tests described in this chapter were done with the Meridian II Precision Time-Base. Meridian II timing components are identical to those in the RTM3205.*

### Software Option

RTIC is a software option in the RTM3205. Read *Appendix I - Software Options* if you need information on how to install a software option. If you are unsure whether your device has RTIC installed, use the `installed_sw_opts` command:

Command: `installed_sw_opts`

Tycho II reply: <no reply>

or

Command: `installed_sw_opts`

Tycho II reply: **The Real-Time Iono Corrections Option is Installed.**

If you would like RTIC and it is not installed, then contact EndRun Technologies.

### About RTIC

The Real-Time Ionospheric Corrections (RTIC) software option for the RTM3205 Precision Time-Base optimizes time and frequency stability and accuracy. The RTIC option uses proprietary algorithms within EndRun's L1 GPS timing receiver to directly measure and remove ionospheric delays in real-time. This unprecedented real-time capability was previously only available with expensive dual frequency L1/L2 GPS receivers.

### **Ionospheric Delay and Impact To GPS Time-Transfer**

The largest contributor to GPS time-transfer error is the variable delay of the satellite signals as they pass through the ionosphere, a layer of ionized particles a few hundred kilometers above the Earth's surface. The ionization is caused by solar radiation phenomena, and is maximum a little after local noon and minimum a little after local midnight. The GPS signal delay through the ionosphere is proportional to the ionization level, expressed as Total Electron Content (TEC). Data transmitted from the satellites contain a model (Klobuchar) that receivers may use to partially compensate for this delay. This model, however, provides only a coarse compensation for night-to-day variations in the ionosphere. It is unable to compensate for the much shorter-term variations in the ionospheric delay caused by various types of solar "storms", and it cannot keep up with the day-to-day variations. As such it was never intended to achieve more than about a 50% improvement over not compensating for the ionospheric delay at all.

### Our Proprietary Solution

The GPS code modulation and carrier phase delays are affected differently as they propagate through the ionosphere. By recognizing a few other aspects of this behavior, EndRun developed the RTIC algorithm to directly quantify the delay through the ionosphere, and resolve the code phase and carrier phase bias. The bias information enables real-time measured delay compensation in EndRun’s proprietary, single-frequency, L1 GPS receiver. *To our knowledge, this capability is unique to End-Run Technologies.*

The algorithm is effective when the receiver is operating at a stationary location with continuous tracking of at least one satellite at all times. After a 24-hour initialization period it begins producing real-time ionospheric delay measurements, with full accuracy of those measurements achieved after several days. When ionospheric conditions are quiet or relatively normal, this option improves the accuracy and stability of the timing outputs by as much as a factor of three at observation intervals between 3,000 and 100,000 seconds. During a major ionospheric storm event, the improvement may be much greater. It is very difficult to achieve this stability over these observation intervals by another method, as only a high-performance cesium frequency standard is stable enough to act as a filter for the timing errors caused by the GPS broadcast model. The following phase plot shows the Meridian II / RTM3205 with the RTIC option active (blue) compared to what the performance would have been using the GPS broadcast model (red). Throughout the 10-day test period the RTIC option demonstrated substantial improvement to frequency and time-domain stability through real-time ionospheric delay measurements and compensation.

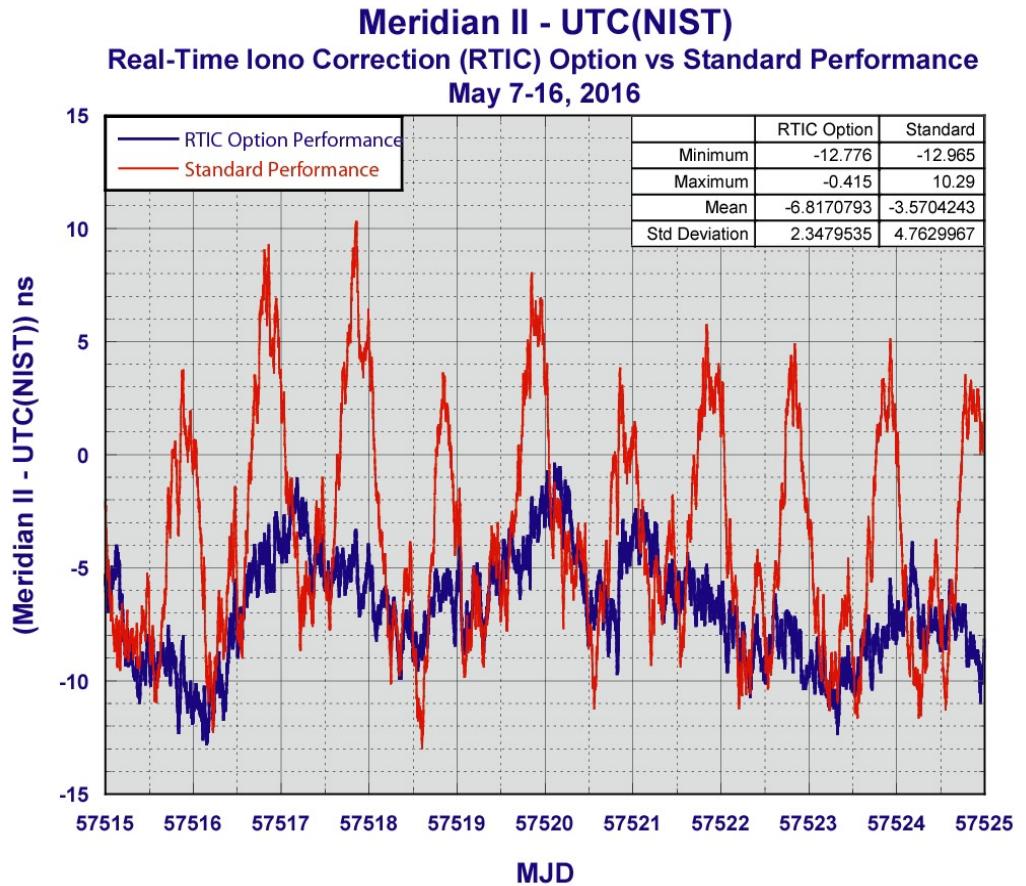

**Performance Verified at National Institute of Standards and Technology (NIST)**

To characterize the performance gain of the RTIC Option, a Meridian II was sent to NIST in May of 2016, where its 1PPS output was monitored continuously relative to UTC(NIST) for over 30 days. The RTIC Option was active in the Meridian II during this time. The ionospheric delay corrections calculated using the broadcast ionospheric model, along with the real-time corrections computed using the RTIC Option, were logged. With these logs, the NIST timing measurements were post-processed to determine what the performance would have been if the RTIC Option had not been active, and the broadcast model had instead been used.

The following chart shows the difference in stability between the two delay compensation methods of the Meridian II / RTM3205, along with the stability of the two performance levels of HP 5071 Cesium standards for comparison. The Meridian II / RTM3205 stability performance with the RTIC option exceeds the standard HP 5071 Cesium at all measurement intervals and exceeds the High Performance HP 5071 after 300,000 seconds.

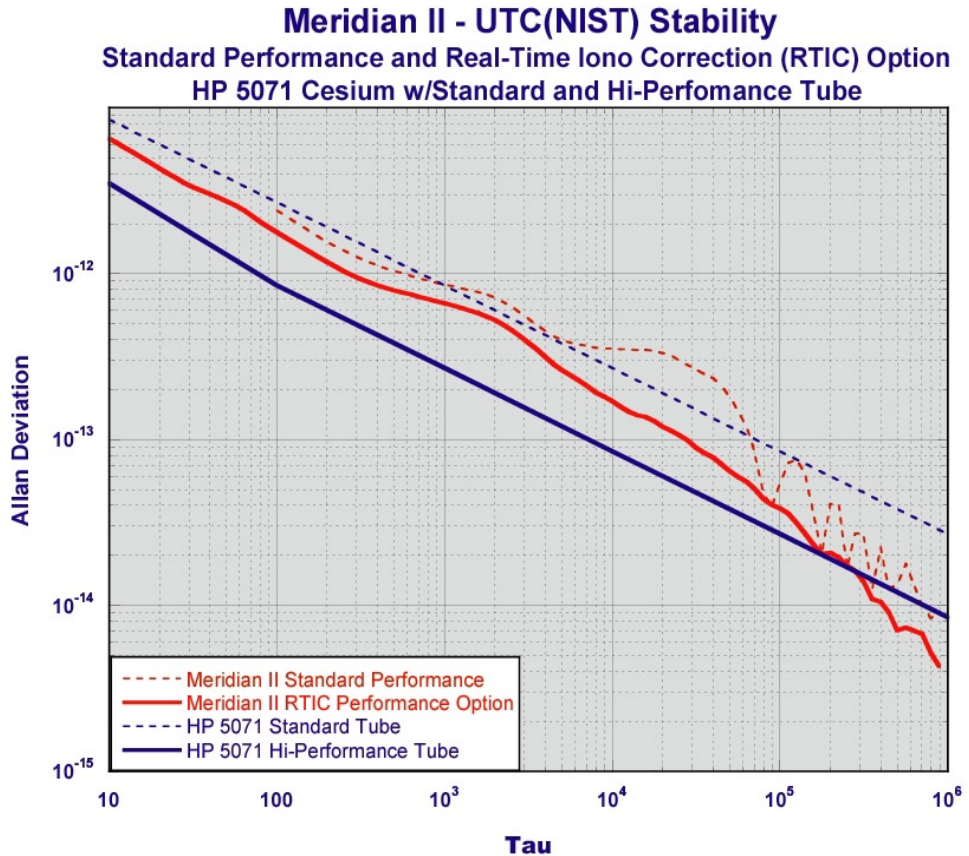

## RTIC Configuration and Status

If the RTIC Option is installed in your unit, then you can configure (turn on or off) and get status information via the command line interface. To confirm whether this option is installed from the command line issue the following command:

```
Command:      installed_sw_opts
RTM3205 reply: The Real-Time Iono Corrections Option is Installed.
               (If the option is installed.)
```

If you need information on how to install the RTIC option, refer to *Appendix I - Software Options*.

### RTIC Configuration and Status Using the Network or Serial Port

The commands listed below allow you to get the current RTIC status and turn RTIC on or off.

#### ionostat

This command shows parameters associated with the RTIC Option. The string contains several parameters in the format shown below:

```
YYYYMMDD.HH:MM:SS K.KKKe-KK V +S.SSSe-SS
```

where:

YYYYMMDD.HH:MM:SS is the timestamp of the data.

K.KKKe-KK is the standard broadcast Klobuchar model ensemble ionospheric delay in seconds.

V is the validity of the Real-Time ionospheric delay calculations, T(rue) or F(alse).

+S.SSSe-SS is the Real-Time ensemble ionospheric delay calculation in seconds.

Here is an example:

```
Command:      ionostat
RTM3205 reply: 20160916.18:13:10 1.093e-08 F +1.093e-08
```

#### rticmode

This command shows the operating state of the Real-Time Ionospheric Correction Option. It is either OFF or ON. When ON, Real-Time ionospheric delays are calculated and used to compensate for the GPS signal delay through the ionosphere. When OFF, the Real-Time delays continue to be calculated but the standard broadcast Klobuchar ionospheric model delays are used to compensate for the GPS signal delay through the ionosphere.

```
Command:      rticmode
RTM3205 reply: ON
```

### setrticmode

This command allows the root user to manually set the Real-Time Ionospheric Correction Option mode to either OFF or ON. For the highest accuracy and stability at a static location with good satellite visibility, this should be set to ON. Even if this setting is ON, it will be ignored if the GPS Dynamic mode is also ON, and real-time ionospheric delays will not be calculated. Factory default mode is ON.

NOTE: The Real-Time Ionospheric Correction Option requires a minimum of 24 hours of operation after lock to GPS to begin producing enhanced accuracy ionospheric delay calculations, and these will reach their full accuracy after several days.

It accepts one command line argument: either ON or OFF. Use the `rticmode` command to confirm any change in setting.

```
Command:      setrticmode ON
RTM3205 reply: Real-Time Ionospheric Corrections Mode is ON
```

### RTIC Performance Plots Using the HTTP Interface

Plots showing the Ensemble Ionosphere Delays are available on the Plots Page as shown below:

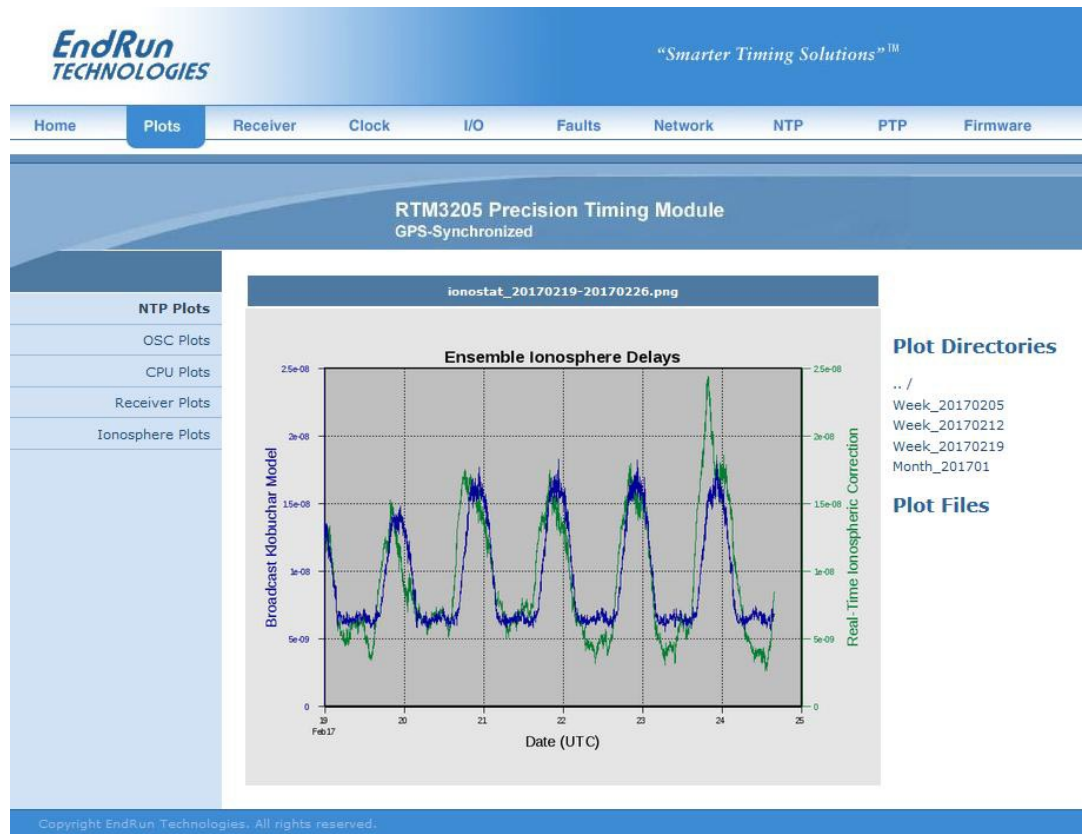

## RTIC Stability Specifications

The specifications shown here supercede the 1PPS Stability specifications in *Appendix K - Specifications*.

*1PPS Stability (RTIC Option):* TDEV < 2 ns @  $\tau < 10^5$  seconds,  $\sigma_y(\tau) < 4.0 \times 10^{-14}$  @  $\tau = 10^5$  secs.

### System Oscillator Stability (Allan Deviation) Table:

Tau in Seconds	MS-OCXO	HS-OCXO	US-OCXO
1	$3.0 \times 10^{-12}$	$1.0 \times 10^{-12}$	$6.0 \times 10^{-13}$
10	$3.9 \times 10^{-12}$	$1.3 \times 10^{-12}$	$6.0 \times 10^{-13}$
100	$3.0 \times 10^{-12}$	$1.7 \times 10^{-12}$	$8.5 \times 10^{-13}$
1000	$2.0 \times 10^{-12}$	$1.3 \times 10^{-12}$	$7.0 \times 10^{-13}$
10000	$2.0 \times 10^{-13}$	$2.0 \times 10^{-13}$	$2.0 \times 10^{-13}$
100000	$4.0 \times 10^{-14}$	$4.0 \times 10^{-14}$	$4.0 \times 10^{-14}$



# Chapter Twelve

## Optional Synchronous Ethernet (SyncE)

When locked to GPS, the RTM3205 can operate as a Synchronous Ethernet Primary Reference Clock (PRC). This chapter contains the information for the optional Synchronous Ethernet protocol (SyncE). SyncE is most often used in telecom applications.

### Software Option

The Synchronous Ethernet protocol is an optional feature in the RTM3205. Read *Appendix I - Software Options* if you need information on how to install a software option. If you are unsure whether your device has SyncE installed, use the `installed_sw_opts` command:

```
Command:      installed_sw_opts
```

```
RTM3205 reply: <no reply>
```

or

```
Command:      installed_sw_opts
```

```
RTM3205 reply: The SyncE Option is Installed.
```

If you would like SyncE and it is not installed, then contact EndRun Technologies.

### About SyncE

Synchronous Ethernet, also referred as SyncE, is an ITU-T standard for computer networking that facilitates the transference of clock signals over the Ethernet physical layer (Layer 1). In addition to the physical clock signals, the Synchronization Status Messaging (SSM) is transmitted on the data link layer (Layer 2). The Ethernet Synchronization Messaging Channel (ESMC) contains the clock Quality Level (QL) with the embedded SSM code.

The RTM3205 is configured as a Synchronous Ethernet Primary Reference Clock (PRS) when tightly locked to GPS (TFOM <= 4. See *Appendix A - TFOM*). There is no SyncE user configuration required.

Synchronous Ethernet is defined in the ITU-T:

- G.8261 Architecture and wander performance

- G.8262 Timing characteristics

- G.8264 Ethernet Synchronization Message Channel (ESMC)

More information on SyncE can be found at the ITU-T Telecommunications Standardization Sector website:

[itu.int/en/ITU-T/Pages/default.aspx](http://itu.int/en/ITU-T/Pages/default.aspx)

## Operation

As stated above, the clock signal is transmitted on Layer 1 (physical) and the Synchronization Status Messaging (SSM) is transmitted on layer 2 (data link). If SyncE is enabled, you would use `syncestat` for the SSM code.

Verify that the network settings have been configured and tested using `netconfig`. Once the network has been configured, the RTM3205 will synchronize the Ethernet and begin to transmit the SSM code.

The Ethernet Synchronization Messaging Channel (ESMC) contains the clock Quality Level (QL) with the embedded SSM code. The ESMC data will be sent at a rate of once per second.

## Status

The `syncestat` command allows you to query the status of SyncE. When the clock is locked, the ESMC and `syncestat` will report the quality level of QL-PRC and set the SSM code. When the clock is not locked (TFOM > 4), `syncestat` will report the quality level of QL-DNU and set the SSM code.

QL-PRC: Primary Reference Clock that is defined in ITU-T G.811.

QL-DNU: Do Not Use this signal for synchronization.

For example:

```
Command:      syncestat
RTM3205 reply: SSM Code: QL-PRC
```

or

```
Command:      syncestat
RTM3205 reply: SSM Code: QL-DNU
```

## Disable the SyncE Protocol

The instructions below assume that the SyncE Option has been installed on your RTM3205. To check, see the section titled *Option* at the beginning of this chapter.

To disable SyncE issue the following command:

```
chmod -x /etc/rc.d/rc.synced
```

Copy the `rc.synced` file to the non-volatile FLASH area like this:

```
cp -p /etc/rc.d/rc.synced /boot/etc/rc.d
```

Then:

**reboot**

Once SyncE has been disabled, it will no longer execute. However, the web interface will still show SyncE and the **syncestat** command will still exist on the system.

### **Re-Enable SyncE**

To re-enable SyncE, remove the *rc.synced* file from the */boot/etc/rc.d* directory as shown below:

```
rm /boot/etc/rc.d/rc.synced
```

Then:

**reboot**

This page intentionally left blank.

# Appendix A

## *Time Figure of Merit (TFOM)*

*This appendix describes the Time Figure of Merit number. The TFOM number indicates the level of accuracy that should be included in the interpretation of the time-of-day and ranges from 3 to 9:*

3	time error is < 100 nanoseconds
4	time error is < 1 microseconds
5	time error is < 10 microseconds
6	time error is < 100 microseconds
7	time error is < 1 milliseconds
8	time error is < 10 milliseconds
9	time error is > 10 ms, unsynchronized state if never locked to GPS

In all cases, the RTM3205 reports this value as accurately as possible, even during periods of GPS signal outage where the RTM3205 is unable to directly measure the relationship of its timing outputs to UTC. During these GPS outage periods, assuming that the RTM3205 had been synchronized prior to the outage, the RTM3205 extrapolates the expected drift of the RTM3205 timing signals based on its knowledge of the characteristics of the system oscillator - Oven Controlled Crystal Oscillator (OCXO). The extrapolated TFOM is based on a conservative estimate of the performance of the oscillator and should be considered 'worst case' for a typical benign ambient temperature environment.

Due to this extrapolation behavior, after initial synchronization, brief periods without GPS satellite visibility will not induce an immediate alarm condition. (Removal of the antenna to simulate this will induce an immediate alarm, however.) If the condition persists for long enough periods, you should see the TFOM character change to indicate a gradually deteriorating accuracy of the timing outputs. If the signal loss condition persists longer, then the final, unsynchronized state will eventually be reached. If the RTM3205 is unable to re-synchronize within one hour after reaching this state, the Alarm LED will light and the **faultstat** command will show a No Signal Time-Out fault.

Once the RTM3205 reaches the unsynchronized TFOM state, then the Network Time Protocol (NTP) daemon will report that it is running at stratum 16 and the leap indicator bits will be set to the fault state. NTP clients will recognize this and cease to use the unsynchronized server.

---

## APPENDIX A

This page intentionally left blank.

# Appendix B

## Upgrading the Firmware

Periodically, EndRun Technologies will make bug fixes and enhancements to our products available for download from our website. All such downloads are freely available to our customers, without charge. You may securely upgrade your RTM3205 firmware via the HTTPS interface or the console port (network/serial). Software upgrades for the RTM3205 are available at this link:

[endruntechnologies.com/support/software-upgrades/rtm3205](http://endruntechnologies.com/support/software-upgrades/rtm3205)

### NOTE

The RTM3205 firmware consists of several different binary files. You may only need one or two of them. The revision history on our website will tell you which files need to be upgraded. The firmware image files are for the Linux RFS (root file system), the Linux Kernel, GPS Subsystem and the GPS Receiver. (The GPS Receiver FPGA is rarely, if ever, upgraded.)

### Upgrade via the HTTPS Interface

Software upgrades via the HTTPS interface are simple, with your choice of two methods:

1. If your RTM3205 has access to the Internet, the HTTPS interface can automatically retrieve the appropriate files from the FTP server at **endruntechnologies.com** to temporary locations on the RTM3205. You will need to enter “root” as the user name and enter root’s password. Then follow the prompts from the HTTPS interface to complete each upgrade as needed.

### IMPORTANT

The domain name server IP address is required by the Apache web server. When using `netconfig` (see **Chapter 3 - Console Port Control and Status**) to configure the TCP/IP parameters be sure to configure a name server. Only one name server is required but two gives some redundancy. The HTTPS Interface will not operate properly if this is configured incorrectly.

The following picture shows the Linux RFS (root file system) Upgrade page. All fields are filled in with the default values needed to download the appropriate firmware image from the EndRun Technologies website. You can use these default values unless you want to point to a different FTP server.

EndRun TECHNOLOGIES "Smarter Timing Solutions"™

Home Plots Receiver Clock I/O Faults Network NTP PTP **Firmware**

RTM3205 Precision Timing Module  
GPS-Synchronized

Firmware Status  
**Linux RFS Upgrade**  
Linux Kernel Upgrade  
GPS Subsystem Upgrade  
GPS Receiver Upgrade  
Reboot

Upgrade from a FTP server.

File Name  
6010-0069-000.gz

FTP Server Name  
endruntechnologies.com

FTP Login Name  
anonymous

FTP Login Password  
YourPassword

**SUBMIT**

Upgrade from a local file that was previously downloaded from endruntechnologies.com

**Browse...** No file selected.

**SUBMIT**

Please wait after pressing Submit. This may take about 60 seconds.

Copyright EndRun Technologies. All rights reserved.

2. If your RTM3205 does not have access to the Internet, you must first download the appropriate file(s) from the EndRun Technologies website to the computer that you will be using later to access the RTM3205 via its HTTPS interface. Use this link to get the file(s) you want:

[endruntechnologies.com/support/software-upgrades/rtm3205](http://endruntechnologies.com/support/software-upgrades/rtm3205)

After saving the file(s), use the RTM3205 HTTPS interface to select one or more for upload to the RTM3205. Then follow the remaining prompts from the HTTPS interface to complete the upgrade(s). (You will need to enter "root" as the user name and enter root's password.)

Upgrade from a local file that was previously downloaded from endruntechnologies.com

**Browse...**

**SUBMIT**

Please wait after pressing Submit. This may take about 60 seconds.



## Upgrade via the Console Port

In order to upgrade via the console port (network or serial) you will need to first download the appropriate firmware image from our website. The RTM3205 firmware consists of four different binary files. You may only need one or two of them. The revision history on our website will tell you which files need to be upgraded. The firmware image files are for the Linux RFS (root file system), the Linux Kernel, the GPS Subsystem and the GPS Receiver. Here is the website link:

[endruntechnologies.com/support/software-upgrades/rtm3205](http://endruntechnologies.com/support/software-upgrades/rtm3205)

### Performing the Linux RFS Upgrade

#### NOTE TO LINUX GEEKS

There are two FLASH disk partitions which hold the compressed Linux root file system images. These partitions are raw FLASH blocks, have no file system and may not be mounted. They are accessed through low-level device drivers. To protect the factory root file system from accidental erasure or over-writing, the upgrade utilities you will be using will only access the upgrade root file system partition. When performing an upgrade, you will be erasing and then copying the new image to this device.

First you need to download the Linux RFS firmware from the EndRun website to a place on your network which is accessible to the RTM3205. The link to the RTM3205 upgrade page is shown above.

#### CAUTION

Some browsers will automatically unzip the file when downloading from the website. Please make sure that the downloaded file size matches what the website says it should be. Upgrading the partition with a too-large file size will cause problems.

#### Transfer File to RTM3205

You may transfer the file to your RTM3205 using either **ftp** or **scp**. If you are using **ftp**, transfer the previously downloaded file using *binary* transfer mode from the remote host to this specific file on your RTM3205: */tmp/rootfs.gz*. The root file system image will be named with the software part number and version like: *6010-0069-000\_3.00.gz*. When following the instructions below, substitute the name of the actual root file system image that you are installing for *6010-0069-000\_3.00.gz*. Issue these commands from the console of your RTM3205:

```
ftp remote_host           {perform ftp login on remote host}
bin                       {set transfer mode to binary}
get 6010-0069-000_3.00.gz /tmp/rootfs.gz {transfer the file}
quit                     {close the ftp session after transfer }
```

---

## APPENDIX B

If you are using **scp**, you may open a command window on the remote computer and securely transfer the root file system image from the remote computer to your RTM3205. A command like this should be used:

```
scp -p 6010-0069-000_3.00.gz root@host.your.domain:/tmp/rootfs.gz
```

Now issue the following command to the RTM3205 console to initiate the upload:

```
upgraderootfs
```

Next, update the default file system partition by issuing this command to your RTM3205 console:

```
updaterootflag 1
```

You should see this line displayed:

```
Default Root File System now set to: UPGRADE
```

Finally, reboot the system by issuing this command at the shell prompt:

```
reboot
```

Wait about 90 seconds for the system to shutdown and reboot. Then log in to the RTM3205 using **telnet** or **ssh**. If all has gone well, you should be able to log in the usual way. After you have entered your password, the system version message will be displayed. You should notice that it now indicates the software version and date of the upgrade that you previously downloaded. You can also check this at any time by issuing

```
sysversion
```

which will cause the system version message to be re-displayed.

You can also check to see which root file system image the system is currently booted under by issuing this command at the shell prompt:

```
sysrootfs
```

Which should cause this to be printed to the console:

```
BOOTED ROOT FILE SYSTEM IMAGE = 1 (Upgrade)
```

If so, and your unit seems to be operating normally, you have successfully completed the root file system upgrade. If your unit does not boot up successfully, and you are not able to **telnet** or **ssh** into the system after 90 seconds, then there has been some kind of problem with the root file system upgrade. It is possible that the file downloaded was corrupt or that you forgot to set your FTP download file mode to binary when downloading the file--either from the EndRun Technologies website or when transferring it to the RTM3205.

### Recovering from a Failed RFS Upgrade

To restore your RTM3205 to a bootable state using the factory root file system, you must use the serial I/O port and reboot the RTM3205 by cycling the power. Refer to *Chapter 2 – Basic Installation, Connect the Serial I/O Port and Test the Serial I/O Port* for setup details. When you have connected your terminal to the serial I/O port, apply power to the RTM3205.

Pay close attention to the terminal window while the unit is rebooting. After the Linux bootloader displays the message

```
Default kernel: FACTORY
To override and boot the UPGRADE version of the kernel,
type UPGRADE within 5 seconds
.....
Booting with FACTORY Kernel
```

```
Default Root File System: UPGRADE
To override and boot the FACTORY version of the Root File System,
type FACTORY within 5 seconds
```

you must begin typing “factory” within five seconds to let the bootloader know that you are going to override the default root file system. After you hit <enter> the bootloader will boot the factory root file system. Watch the rest of the boot process to make sure that you have successfully recovered. If the system boots normally, then you should resolve the problems with the previous root file system upgrade and re-perform it.

### Performing the Linux Kernel Upgrade

First you need to download the Linux Kernel firmware from the EndRun website to a place on your network which is accessible to the RTM3205. The link to the RTM3205 upgrade page is shown above.

#### Transfer File to RTM3205

You may transfer the file to your RTM3205 using either **ftp** or **scp**. If you are using **ftp**, transfer the previously downloaded file using *binary* transfer mode from the remote host to this specific file on your RTM3205: */tmp/kernel.gz*. The kernel image will be named with a software part number like: *6010-0064-000\_2.00.uImage*. When following the instructions below, substitute the name of the actual kernel image that you are installing for *6010-0064-000\_2.00.uImage*. Issue these commands from the console of your RTM3205:

```
ftp remote_host           {perform ftp login on remote host}
bin                       {set transfer mode to binary}
get 6010-0064-000_2.00.uImage /tmp/kernel.gz  {transfer the file}
quit                      {close the ftp session after transfer }
```

If you are using **scp**, you may open a command window on the remote computer and securely transfer the kernel image from the remote computer to your RTM3205. A command like this should be used:

```
scp -p 6010-0064-000_2.00.uImage root@host.your.domain:/tmp/kernel.gz
```

Now issue the following command to the RTM3205 console to initiate the upload:

```
upgradekernel
```

Next, update the default file system partition by issuing this command to your RTM3205 console:

```
updatekernelflag 1
```

You should see this line displayed:

```
Default Kernel now set to: UPGRADE
```

Finally, reboot the system by issuing this command at the shell prompt:

```
reboot
```

Wait about 90 seconds for the system to shutdown and reboot. Then log in to the RTM3205 using **telnet** or **ssh**. If all has gone well, you should be able to log in the usual way. You can check the running kernel version at any time by issuing

```
kernelversion
```

which will cause the kernel version message to be displayed.

You can also check to see which kernel image the system is currently booted under by issuing this command at the shell prompt:

```
syskernel
```

Which should cause this to be printed to the console:

```
BOOTED KERNEL IMAGE = 1 (Upgrade)
```

If so, and your unit seems to be operating normally, you have successfully completed the kernel upgrade. If your unit does not boot up successfully, and you are not able to **telnet** or **ssh** into the system after 90 seconds, then there has been some kind of problem with the kernel upgrade. It is possible that the file downloaded was corrupt or that you forgot to set your **ftp** download file mode to binary when downloading the file--either from the EndRun Technologies website or when transferring it to the RTM3205.

### **Recovering from a Failed Kernel Upgrade**

To restore your RTM3205 to a bootable state using the factory kernel, you must use the serial I/O port and reboot the RTM3205 by cycling the power. Refer to *Chapter 2 – Basic Installation, Connect the Serial I/O Port and Test the Serial I/O Port* for setup details. When you have connected your terminal to the serial I/O port, apply power to the RTM3205.

Pay close attention to the terminal window while the unit is rebooting. After the Linux bootloader displays the message

### Default kernel: UPGRADE

To override and boot the **FACTORY** version of the kernel, type **FACTORY** within 5 seconds

you must begin typing “factory” within five seconds to let the bootloader know that you are going to override the default kernel. After you hit <enter> the bootloader will boot the factory kernel. Watch the rest of the boot process to make sure that you have successfully recovered. If the system boots normally, then you should resolve the problems with the previous kernel upgrade and re-perform it.

## Performing the GPS Subsystem Upgrade

This section has instructions for upgrading the GPS Subsystem. If you want to upgrade the GPS Receiver, see the section below called *Performing the GPS Receiver Upgrade*.

First you need to download the GPS Subsystem firmware from the EndRun website to a place on your network which is accessible to the RTM3205. The link to the RTM3205 upgrade page is shown above.

You may transfer the file to your RTM3205 using either **ftp** or **scp**. If you are using **ftp** to perform the upgrade, transfer the previously downloaded file using *binary* transfer mode from the remote host to this specific file on your RTM3205: */tmp/subsys.bin*. The GPS Subsystem image will be named with the software part number and version like: *6010-0076-000\_3.01.bin*. When following the instructions below, substitute the name of the actual GPS Subsystem image that you are installing for *6010-0076-000\_3.01.bin*. You will be transferring the file to a temporary file, */tmp/subsys.bin* on your RTM3205.

```
ftp remote_host           {perform ftp login on remote host}
bin                        {set transfer mode to binary}
get 6010-0076-000_3.01.bin /tmp/subsys.bin      {transfer the file}
quit                       {close the ftp session after the transfer }
```

If you are using SSH to perform the GPS Subsystem upgrade, you may open another command window on the remote computer and securely transfer the GPS Subsystem image to */tmp/subsys.bin* using **scp** from the remote computer. A command like this could be used:

```
scp -p 6010-0076-000_3.01.bin root@host.your.domain:/tmp/subsys.bin
```

Now issue the following command to the RTM3205 console to initiate the upload:

```
upgradesubsys
```

This command performs the file transfer to the GPS Subsystem. You will see a file transfer progress message while it is performing the transfer. After it completes, wait about 40 seconds and issue this command to check the GPS Subsystem version:

```
gpsversion
```

You should see a message like this:

```
F/W 6010-0076-000 Ver 3.01 - FPGA 6020-0016-000 Ver 01 - JAN 12 15:30:58 2013
```

The firmware version should match that of the binary file that you uploaded.

### **Problems with the GPS Subsystem Upgrade**

Should you have difficulties with the upgrade due to a corrupt file, power failure during upload, or other accident, do not be alarmed. Even though you may have lost the existing application program, the GPS Subsystem bootloader program will remain intact. Correct any problem with the binary file and retry the upload procedure. If you are still unable to successfully perform the GPS Subsystem upgrade, you should contact Customer Support at EndRun Technologies.

### **Performing the GPS Receiver Upgrade**

This section has instructions for upgrading the GPS Receiver. If you want to upgrade the GPS Subsystem see the section above called *Performing the GPS Subsystem Upgrade*.

First you need to download the GPS Receiver firmware from the EndRun website to a place on your network which is accessible to the RTM3205. The link to the RTM3205 upgrade page is shown above.

You may transfer the file to your RTM3205 using either **ftp** or **scp**. If you are using **ftp** to perform the upgrade, transfer the previously downloaded file using *binary* transfer mode from the remote host to this specific file on your RTM3205: */tmp/rcvr.bin*. The GPS Receiver image will be named with the software part number and version like: *6010-0081-000\_1.04.bin*. When following the instructions below, substitute the name of the actual GPS Receiver image that you are installing for *6010-0081-000\_1.04.bin*. You will be transferring the file to a temporary file, */tmp/rcvr.bin* on your RTM3205.

```
ftp remote_host           {perform ftp login on remote host}
bin                       {set transfer mode to binary}
get 6010-0081-000_1.04.bin /tmp/rcvr.bin {transfer the file}
quit                       {close the ftp session after the transfer }
```

If you are using SSH to perform the GPS Receiver upgrade, you may open another command window on the remote computer and securely transfer the GPS Receiver image to */tmp/rcvr.bin* using **scp** from the remote computer. A command like this could be used:

```
scp -p 6010-0081-000_1.04.bin root@host.your.domain:/tmp/rcvr.bin
```

Now issue the following command to the RTM3205 console to initiate the upload:

```
upgradercvr
```

This command performs the file transfer to the GPS Receiver. You will see a file transfer progress message while it is performing the transfer. Next, issue the following command to the RTM3205 console to reset the GPS Subsystem (and Receiver):

```
subsysreset
```

After it completes, wait about 60 seconds and issue this command to check the GPS Receiver version:

### **rcvrversion**

You should see a message like this:

```
F/W 6010-0081-000 Ver 1.04 - FPGA 6020-0014-000 Ver 01 - JAN 28 13:08:52 2013
```

The firmware version should match that of the binary file that you uploaded.

### **Problems with the GPS Receiver Upgrade**

Should you have difficulties with the upgrade due to a corrupt file, power failure during upload, or other accident, do not be alarmed. Even though you may have lost the existing application program, the GPS Receiver bootloader program will remain intact. Correct any problem with the binary file and retry the upload procedure. If you are still unable to successfully perform the GPS Receiver upgrade, you should contact Customer Support at EndRun Technologies.

### **Performing the GPS Receiver FPGA Upgrade**

This section has instructions for upgrading the Field-Programmable Gate Array (FPGA) resident on the GPS Receiver. This is rarely, if ever, used. Therefore, it's not an option on the HTTPS interface.

First you need to download the FPGA image from the EndRun website to a place on your network which is accessible to the RTM3205. The link to the RTM3205 upgrade page is shown above.

You may transfer the file to your RTM3205 using either **ftp** or **scp**. If you are using **ftp** to perform the upgrade, transfer the previously downloaded file using *binary* transfer mode from the remote host to this specific file on your RTM3205: */tmp/rcvrfpga.rbf*. The FPGA image will be named with the image part number and version like: *6020-0014-000\_02.rbf*. When following the instructions below, substitute the name of the actual FPGA image that you are installing for *6020-0014-000\_02.rbf*. You will be transferring the file to a temporary file, */tmp/rcvrfpga.rbf* on your RTM3205.

```
ftp remote_host           {perform ftp login on remote host}
bin                       {set transfer mode to binary}
get 6020-0014-000_02.rbf /tmp/rcvrfpga.rbf   {transfer the file}
quit                       {close the ftp session after the transfer }
```

If you are using SSH to perform the GPS Receiver upgrade, you may open another command window on the remote computer and securely transfer the FPGA image to */tmp/fpga.bin* using **scp** from the remote computer. A command like this could be used:

```
scp -p 6020-0014-000_02.rbf root@host.your.domain:/tmp/rcvrfpga.rbf
```

Now issue the following command to the RTM3205 console to initiate the upload:

```
upgradercvrfpga
```

This command performs the file transfer to the FPGA on the GPS Receiver. You will see a file transfer progress message while it is performing the transfer. Next, issue the following command to the RTM3205 console to reset the GPS Subsystem (and Receiver):

---

## APPENDIX B

### **subsysreset**

After it completes, wait about 60 seconds and issue this command to check the FPGA version on the GPS Receiver:

### **rcvrversion**

You should see a message like this:

```
F/W 6010-0081-000 Ver 1.04 - FPGA 6020-0014-000 Ver 02 - OCT 11 13:08:52 2015
```

The FPGA version should match that of the binary file that you uploaded.



# Appendix C

## *Helpful Linux Information*

*You do not need knowledge of Linux commands in order to operate RTM3205. All commands necessary for proper operation are described in **Chapter 3 - Console Port Control and Status**. However, the RTM3205 does support a subset of the standard Linux commands and utilities and it uses the **bash** shell, which is the Linux standard, full-featured shell. Very brief descriptions of some of the most useful Linux information is described in this appendix.*

### Linux Users

RTM3205 is shipped from the factory with two users enabled. The first is the “root” user with password “endrun\_1”. The root user has access to everything on the system, including the ability to perform system setup procedures.

The other user is “sysuser” with password “Praecis”. When logged in as sysuser you may check status information and view log files but you will not be able to modify any system settings or view secure files.

For security reasons, we recommend you change the default passwords using the Linux **passwd** command (see *Change Password* below).

### Linux Commands

#### Detailed Information Is Available

A very brief description of the most helpful Linux commands and utilities is listed in this appendix. On Linux systems, the system commands are located in the directories with “bin” in their name, e.g. */usr/bin* or */sbin*. You can list the contents of those directories using the **ls** command to see what is installed on your RTM3205. Then you can find out about those commands using the **man** command, which stands for “manual”. For example, to read details on the **ps** command type this:

```
man ps
```

A very detailed description, called a “man page”, of the **ps** command will be shown. To navigate in the document, press ‘d’ to scroll down, ‘b’ to scroll up, and ‘q’ to quit and return to the command prompt.

To search the database of man pages, use either **apropos** or **whatis**. **apropos** will do partial word searches, while **whatis** will only find matching whole words. For example to find all man pages dealing with ntp:

```
apropos ntp
```

The relevant available man pages are shown:

```
ntp []          (1) - keygen - Create a NTP host key
ntpd []        (1) - NTP daemon program
ntpdc []       (1) - vendor-specific NTP query program
ntpq []        (1) - standard NTP query program
ntpsnmpd []    (1) - NTP SNMP MIB agent
sntp []        (1) - standard SNTP program
```

Now you can issue `man` commands on each of these man pages to find what you are looking for.

### **Change Password**

This command is used to change the password for the user that you are logged in as. It affects the serial port, SSH, Telnet and HTTPS.

```
passwd
```

### **List Active Processes**

This command displays all active processes running in the system.

```
ps -e
```

### **NTP Monitoring and Troubleshooting**

The following command displays which NTP clients are reaching the NTP daemon running on the RTM3205. It will not try to look up host names.

```
ntpq -n -c mrulist
```

A useful command for querying NTP status is the following.

```
ntpq -peers
```

To query a remote time server (if the remote timeserver will accept the query) type:

```
ntpq -peers <hostname>
```

A table of information will be displayed. For details on what each of the table columns means type:

```
man ntpq
```

To see what version of the NTP daemon, `ntpd`, is operating type:

```
ntpd --version
```

## Text Editors

There are three text editors resident on the RTM3205 file system: **edit**, **joe** and **elvis**. All of these may be useful when needing to edit system configuration files or to view and search within system log files.

**joe** is the recommended editor for all purpose use in configuring and monitoring the RTM3205. It is a full-featured editor with syntax highlighting and is also based on the Wordstar commands. It is user friendly with easy to find help for its key commands, and complete man page documentation. It is started by simply issuing the command **joe [file-to-edit]**, optionally with a file name to edit. It is the modern replacement for **edit** (see below).

**edit** is a very simple editor with Wordstar key commands that was originally developed for extremely memory-limited environments, such as floppy boot disks and embedded Linux appliances. When EndRun Technologies' first generation Linux-based embedded network time servers were introduced, they fell into this category and the **edit** text editor was appropriate. Now it is included on the RTM3205 file system for legacy reasons, since it has been the default editor for all first and second generation EndRun Technologies products. A man page for **edit** is resident on the system. When it is first started, and you did not give it a file name to edit on the command line, it shows a start-up screen with its command syntax. But once you have opened a file to edit, online help is not available. It is started by issuing the command **edit [file-to-edit]**, optionally with a file name to edit.

**elvis** is a full-featured **vi** clone which is provided in the RTM3205 file system for masochistic Unix diehards. It is not the least bit user friendly to anyone lacking experience with text mode applications. If you don't know what **vi** is, avoid using this editor! It is started by simply issuing the command **vi [file-to-edit]**, optionally with a file name to edit.

## Change Log-In Banners

There are three different log-in banners in the RTM3205 - the serial port banner, the Telnet banner, and the SSH banner. You must be logged in as the "root" user in order to edit the *rc.local* file and change the log-in banners. Perform the following:

```
edit /etc/rc.d/rc.local
```

Change the banners as appropriate. After saving the file, copy it to */boot/etc* like this:

```
cp -p /etc/rc.d/rc.local /boot/etc/rc.d
```

Then reboot for your changes to take effect.

## Query and Change Ethernet Ports

**ethtool** is a Linux utility that allows you to query or change the settings for Port 0 (**eth0**) and Port 1 (**eth1**). For example, to view current settings for Port 0 issue the following command:

```
ethtool eth0
```

Here is an example of one way to set the speed on Port 0 to 1000Base-T:

```
ethtool -s eth0 speed 1000 duplex full autoneg off
```

The command above will immediately change the port speed to 1000Base-T, but it will revert to its factory (10/100/1000Base-T) at a system reset. If you want to retain the setting after a system reset, then you need to edit the *rc.M* configuration file. Follow this sequence:

1. Edit */etc/rc.d/rc.M* using one of the editors on the previous page. Insert the desired **ethtool** line (see example above) after the Gatekeeper Daemon is started and before the Precision Time Protocol is started. Exit and save the *rc.M* file.

2. Now you need to copy the *rc.M* file into a location that will ensure your changes persist through a system reset. Copy */etc/rc.d/rc.M* to */boot/etc/rc.d* as shown:

```
cp /etc/rc.d/rc.M /boot/etc/rc.d
```

For more details on **ethtool** and how to use it type:

```
man ethtool
```

## Redirect Syslog Files to Remote Host

You can redirect syslog files to a remote host (syslog server) by adding the standard Linux redirect commands to the RTM3205's *syslog.conf* file. Follow this sequence:

1. Edit */etc/syslog.conf* using one of the editors on the previous page. Insert this line:

```
*.* @remote_host
```

Substitute the actual name or IP address of your remote syslog server for "remote\_host". The most common log file to be directed to the Syslog Server is the *messages.log* file which contains authenticated user login activity. If you would like to only redirect this log info to the remote host, insert this line instead of the one above:

```
messages.log @remote_host
```

Exit and save the *syslog.conf* file.

2. Now you need to copy the *syslog.conf* file into a location that will ensure your changes persist through a system reset. Copy */etc/syslog.conf* to */boot/etc/syslog.conf* as shown:

```
cp /etc/syslog.conf /boot/etc/syslog.conf
```

# Appendix D

## *Third-Party Software*

*The RTM3205 Precision Timing Module is running several different software products created and/or maintained by open source projects. Open source software comes with its own license. These are printed out for your information below.*

The license for the GNU software project requires that we provide you with a copy of all source code covered under the GNU Public License (GPL) at your request. Please contact us with your request and we will mail it to you on a CD. We will charge you a fee for our incurred expenses as allowed for in the license.

### **GNU General Public License**

Everyone is permitted to copy and distribute verbatim copies of this license document, but changing it is not allowed.

Preamble

Copyright © 2007 Free Software Foundation, Inc. ( [fsf.org](http://fsf.org) )

The GNU General Public License is a free, copyleft license for software and other kinds of works.

The licenses for most software and other practical works are designed to take away your freedom to share and change the works. By contrast, the GNU General Public License is intended to guarantee your freedom to share and change all versions of a program--to make sure it remains free software for all its users. We, the Free Software Foundation, use the GNU General Public License for most of our software; it applies also to any other work released this way by its authors. You can apply it to your programs, too.

When we speak of free software, we are referring to freedom, not price. Our General Public Licenses are designed to make sure that you have the freedom to distribute copies of free software (and charge for them if you wish), that you receive source code or can get it if you want it, that you can change the software or use pieces of it in new free programs, and that you know you can do these things.

To protect your rights, we need to prevent others from denying you these rights or asking you to surrender the rights. Therefore, you have certain responsibilities if you distribute copies of the software, or if you modify it: responsibilities to respect the freedom of others.

For example, if you distribute copies of such a program, whether gratis or for a fee, you must pass on to the recipients the same freedoms that you received. You must make sure that they, too, receive or can get the source code. And you must show them these terms so they know their rights.

Developers that use the GNU GPL protect your rights with two steps: (1) assert copyright on the software, and (2) offer you this License giving you legal permission to copy, distribute and/or modify it.

For the developers' and authors' protection, the GPL clearly explains that there is no warranty for this free software. For both users' and authors' sake, the GPL requires that modified versions be marked as changed, so that their problems will not be attributed erroneously to authors of previous versions.

Some devices are designed to deny users access to install or run modified versions of the software inside them, although the manufacturer can do so. This is fundamentally incompatible with the aim of protecting users' freedom to change the software. The systematic pattern of such abuse occurs in the area of products for individuals to use, which is precisely where it is most unacceptable. Therefore, we have designed this version of the GPL to prohibit the practice for those products. If such problems arise substantially in other domains, we stand ready to extend this provision to those domains in future versions of the GPL, as needed to protect the freedom of users.

Finally, every program is threatened constantly by software patents. States should not allow patents to restrict development and use of software on general-purpose computers, but in those that do, we wish to avoid the special danger that patents applied to a free program could make it effectively proprietary. To prevent this, the GPL assures that patents cannot be used to render the program non-free.

## NTP Software License

Information about the NTP Project can be found at: [ntp.org](http://ntp.org). The distribution and usage of the NTP software is allowed, as long as the following copyright notice is included in our documentation. For more information see: [opensource.org/licenses/ntp-license.php](http://opensource.org/licenses/ntp-license.php)

```
*****  
*                                                                 *  
* Copyright (c) University of Delaware 1992-2015                *  
*                                                                 *  
* Permission to use, copy, modify, and distribute this software and *  
* its documentation for any purpose with or without fee is hereby  *  
* granted, provided that the above copyright notice appears in all *  
* copies and that both the copyright notice and this permission   *  
* notice appear in supporting documentation, and that the name    *  
* University of Delaware not be used in advertising or publicity   *  
* pertaining to distribution of the software without specific,    *  
* written prior permission. The University of Delaware makes no   *  
* representations about the suitability this software for any      *  
* purpose. It is provided "as is" without express or implied     *  
* warranty.                                                         *  
*                                                                 *  
*****
```

---

## THIRD-PARTY SOFTWARE

```
*****
*
* Copyright (c) Network Time Foundation 2011-2015
*
* All Rights Reserved
*
* Redistribution and use in source and binary forms, with or without
* modification, are permitted provided that the following conditions
* are met:
* 1. Redistributions of source code must retain the above copyright
* notice, this list of conditions and the following disclaimer.
* 2. Redistributions in binary form must reproduce the above
* copyright notice, this list of conditions and the following
* disclaimer in the documentation and/or other materials provided
* with the distribution.
*
* THIS SOFTWARE IS PROVIDED BY THE AUTHORS ``AS IS'' AND ANY EXPRESS
* OR IMPLIED WARRANTIES, INCLUDING, BUT NOT LIMITED TO, THE IMPLIED
* WARRANTIES OF MERCHANTABILITY AND FITNESS FOR A PARTICULAR
* PURPOSE ARE DISCLAIMED. IN NO EVENT SHALL THE AUTHORS OR
* CONTRIBUTORS BE LIABLE FOR ANY DIRECT, INDIRECT, INCIDENTAL,
* SPECIAL, EXEMPLARY, OR CONSEQUENTIAL DAMAGES (INCLUDING, BUT
* NOT LIMITED TO, PROCUREMENT OF SUBSTITUTE GOODS OR SERVICES;
* LOSS OF USE, DATA, OR PROFITS; OR BUSINESS INTERRUPTION) HOWEVER
* CAUSED AND ON ANY THEORY OF LIABILITY, WHETHER IN CONTRACT,
* STRICT LIABILITY, OR TORT (INCLUDING NEGLIGENCE OR OTHERWISE)
* ARISING IN ANY WAY OUT OF THE USE OF THIS SOFTWARE, EVEN IF
* ADVISED OF THE POSSIBILITY OF SUCH DAMAGE.
*****
```

## Apache Software License

Copyright [2013] [EndRun Technologies]

Licensed under the Apache License, Version 2.0 (the "License");  
you may not use this file except in compliance with the License.  
You may obtain a copy of the License at: [apache.org/licenses/LICENSE-2.0](http://apache.org/licenses/LICENSE-2.0)

Unless required by applicable law or agreed to in writing, software  
distributed under the License is distributed on an "AS IS" BASIS,  
WITHOUT WARRANTIES OR CONDITIONS OF ANY KIND, either express or implied.  
See the License for the specific language governing permissions and  
limitations under the License.

## **PTP Software License**

The PTP/IEEE-1588 option as implemented in the RTM3205 is covered by patents and copyrights. For patents that pertain to the Std No 1588, see the IEEE Standards Association.

Information about the PTP Project, led by Kendall Correll, can be found at:

[ptpd.sourceforge.net](http://ptpd.sourceforge.net)

The distribution and usage of the PTP software is allowed, as long as the following copyright notice is included in our documentation. The copyright notice applies to all files which compose the PTPd. This notice applies as if the text was explicitly included in each file.

Copyright (c) 2005-2008 Kendall Correll, Aidan Williams

Permission to use, copy, modify, and/or distribute this software for any purpose with or without fee is hereby granted, provided that the above copyright notice and this permission notice appear in all copies.

THE SOFTWARE IS PROVIDED "AS IS" AND THE AUTHOR DISCLAIMS ALL WARRANTIES WITH REGARD TO THIS SOFTWARE INCLUDING ALL IMPLIED WARRANTIES OF MERCHANTABILITY AND FITNESS. IN NO EVENT SHALL THE AUTHOR BE LIABLE FOR ANY SPECIAL, DIRECT, INDIRECT, OR CONSEQUENTIAL DAMAGES OR ANY DAMAGES WHATSOEVER RESULTING FROM LOSS OF USE, DATA OR PROFITS, WHETHER IN AN ACTION OF CONTRACT, NEGLIGENCE OR OTHER TORTIOUS ACTION, ARISING OUT OF OR IN CONNECTION WITH THE USE OR PERFORMANCE OF THIS SOFTWARE.



# Appendix E

## Installing the GPS Antenna

*This appendix contains guidelines for installing the GPS antenna. Mounting the antenna with a good view-of-the-sky is very important. A rooftop installation is usually best. The accuracy & stability specifications in Appendix K - Specifications assume an antenna installation with a very good view-of-the-sky.*

### Antenna Location

The location of the antenna must be chosen based on having as clear a view of the sky as possible. Any obstructions such as buildings, large metal objects or other antennas, and even trees, will limit the performance of the GPS antenna. The antenna should also be located away from overhead power lines or circuits, for safety reasons. The illustration below shows some examples of good and bad antenna mounting locations.

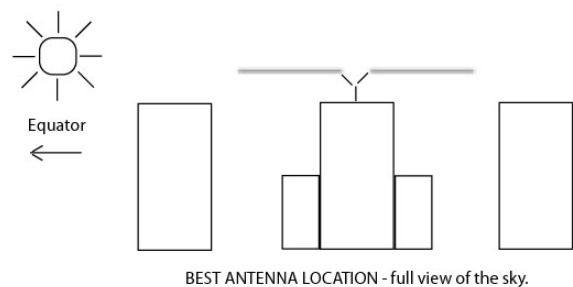
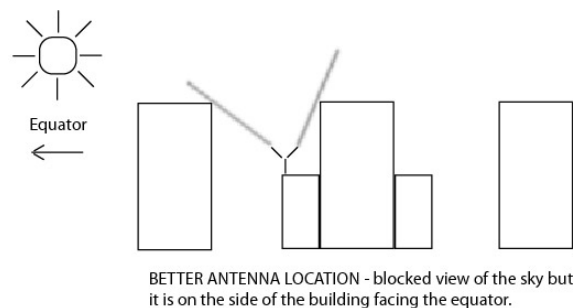
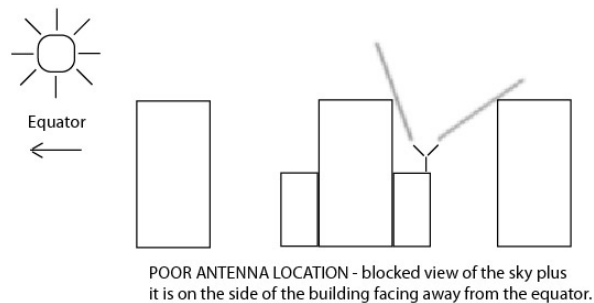

## GPS Antenna Kit

The RTM3205 typically ships with a GPS Antenna Kit which includes 50 feet (15 meters) of antenna cable. This amount of cable is sufficient for the majority of GPS antenna installations. Longer cable runs can also be accommodated. Figure 1 shows the GPS antenna rooftop mounting hardware. Below is a list of the items in a typical GPS Antenna Kit, part number 0610-0009-001:

- GPS Antenna (part #0502-0013-000)
- Antenna Mounting Adaptor (part #0602-0035-000)
- PVC Mounting Pipe (part #0602-0060-018)
- Hose Clamps (part #0100-0008-000)
- 50 feet of RG-59U (Belden 9104) Cable/TNC Male (part #0600-0013-050)
- A GPS Rooftop Installation Guide (part #5050-0017-000).

\*\* NOTE: If you will not be using the EndRun-supplied cable, then please read the section below called *Recommended Cable*.

## About Coax Cable

The GPS signal frequency is considered to be in the microwave range and is highly affected by impedance mismatches and discontinuities in the transmission cables. All RF coax cables have a minimum bend radius. In order to prevent damage, cable should not be bent into tight curves. It is critically important during installation that kinks are not allowed to form in the cable. If RF coax cable is bent beyond its minimum bend radius, then damage to the inner construction of the cable may result. This can lead to much higher levels of loss and a non-functioning GPS receiver.

Similarly, care should be taken to ensure that the cable is not crushed, or likely to be crushed later. If the RF coax cable does suffer this kind of damage, then the dimensions of the cable will be changed and it will not maintain its characteristic impedance. Again, this can result in a non-functioning GPS receiver.

### IMPORTANT

Care must be taken when installing the GPS cable. Do not treat it like a power extension cord or garden hose. Please:

- Do not allow kinks to form in the cable at any time.
- Ensure that the cable is not crushed at any time.
- Do not bend the cable into tight curves.

Ignoring these precautions may damage the cable and cause a myriad of GPS reception problems.

## Long Cable Runs

Most devices are installed with only 50 feet (15 meters) of antenna cable. However, there are many circumstances where 50 feet is inadequate. We can accommodate cable lengths up to 1000 feet using a combination of low-loss cable and preamplifiers.

### Recommended Cable

The factory-supplied GPS cable is an RG-59 type. RG-59 is a broad classification, with wide variation in performance between cables from different manufacturers and for different applications. We supply two specific cables: Belden 9104 or Belden 1505A. Belden 9104 is constructed with a copper-plated steel center conductor and an aluminum outer braid. Belden 1505A is constructed of all solid copper conductors. Both cables are double shielded, low-loss cables designed for the cable TV industry, and they both have a signal loss of 10 dB/100 feet at GPS frequencies. The Belden 1505A also has very low DC resistance, which is important for long cable runs. For very long cables, if the DC resistance is too high, not enough voltage will be available at the end farthest from the RTM3205 where the antenna and preamplifiers are installed. For cable lengths less than 700 feet, Belden 9104 is acceptable.

#### IMPORTANT

If you are supplying the cable for your GPS installation, then you must make sure the cable you install is comparable to the Belden 9104 or Belden 1505A. Specifically, the cable must:

- Be double-shielded
- Have 10 dB or less of loss per 100 feet at 1.5 GHz.
- Have very low DC resistance (for cable lengths > 700 feet)

Choosing an inferior cable type can cause a myriad of GPS reception problems.

### Using GPS Low-Noise Amplifiers (LNAs)

For longer cable lengths, you will need one or more LNAs (see chart below). We produce the G-LNA2 which is a very high-performance, low-noise, low-power drain, inline amplifier for difficult GPS signal environments and long cable runs (greater than 250 feet of factory-supplied cable). The following table shows the number of LNAs we recommend for each GPS antenna installation using our factory-supplied cable. Installations using other cable types may have different preamplifier requirements.

Cable Length	Cable Type	Number of LNAs
Up to 250 feet (76 meters)	Belden 9104 or equivalent	0
251 to 500 feet (77 to 152 meters)	Belden 9104 or equivalent	1
501 to 700 feet (153 to 213 meters)	Belden 9104 or equivalent	2
701 to 750 feet (214 to 228 meters)	Belden 1505A or equivalent	2
751 to 1000 feet (229 to 305 meters)	Belden 1505A or equivalent	3

An Installation Guide for installing a rooftop-mounted antenna and a GPS preamplifier is shown at the end of this appendix in Figures 1 and 2.

#### Using Two or Three LNAs

Installation for one LNA is simple. But the physical layout of two or three LNAs is critical. An improper installation can cause feedback from the output of the last LNA, through the cable shield and back up to the antenna. This highlights the importance of properly constructed cable terminations and double shielded cable.

#### IMPORTANT

Proper installation of two or three LNAs is critical:

Use the appropriate cable as specified in the previous section *Long Cable Runs*.

Ensure properly constructed cable terminations.

LNAs must be installed in a straight line down from the bottom of the antenna (no bends or loops).

An improper installation may create problems for your GPS receiver and any antennas nearby.

For installations using three preamps, we recommend that the last pre-amp be located as far as is practical from the antenna. This is because the antenna and three preamplifiers will have more than 100 dB of gain, increasing the likelihood that enough leakage from the cable can cause “round-the-world” feedback to the antenna and set up oscillation. Here is the suggested configuration for an antenna installation with two or three preamplifiers:

<u>Two LNAs</u>	<u>Three LNAs</u>
GPS Antenna	GPS Antenna
One-foot cable	One-foot cable
LNA	LNA
One-foot cable	One-foot cable
LNA	LNA
Up to 750 feet (228 meters) of cable	Up to 1000 feet (305 meters) of cable
RTM3205 Precision Timing Module	LNA
	One-foot cable
	RTM3205 Precision Timing Module

## Other Accessories

### Lightning Arrestor

A lightning arrestor helps protect your GPS installation from damage due to lightning strikes. It is designed to pass the DC voltage that is needed to power the antenna and/or preamps without degrading the GPS signal. It is installed between the antenna and the receiver where the cable enters the building, near an earth-ground. You must bond the lightning arrestor to the earth-ground.

### Signal Splitters

Signal splitters are used when two GPS receivers are sharing one antenna installation. The smart GPS Splitter supplied by EndRun is a one-input, two-output device. In the normal configuration, one of the splitter RF outputs (J1) passes DC from the connected GPS Receiver through the splitter to the antenna, allowing the GPS Receiver to power both the antenna and the splitter amplifier. The other RF output (J2) is DC loaded with a 200-ohm resistor to simulate the antenna current draw.

When selecting and installing a signal splitter keep these points in mind:

1. The splitter must be DC-blocked on one leg. The GPS Receiver in EndRun's products provide +5 VDC up the coax to power the GPS antenna's built-in preamp. The two GPS receivers connected to the splitter outputs must not have their power sources connected together.
2. It is desirable that the DC-blocked leg has a DC load resistor to simulate a GPS antenna load. This way you will not get a false alarm from the GPS Receiver's antenna load sensor. However, the RTM3205 allows you to mask an antenna fault alarm from causing a system fault by using the `se-tantflmask` command. See details in *Chapter 3 - Console Port Control and Status*.
3. The signal splitter supplied by EndRun has a built-in preamplifier to compensate for signal loss through the splitter. If using a splitter other than the one supplied by EndRun you may need to compensate for splitter signal loss by using a separate GPS preamplifier.

## Calibrate Your Receiver

In order for the RTM3205 to synchronize with maximum accuracy to UTC, the delay for the cable and all devices between the antenna and the GPS receiver input (i.e. GPS preamplifiers, signal splitters, lightning arrestors, etc.) must be compensated for. You can do this via the console port `caldelay` and `setcaldelay` commands (see *Chapter 3 - Console Port Control & Status*).

Calibration is used to compensate for the propagation delay between the GPS antenna and the RTM3205 GPS receiver input connector. Positive values remove delay by advancing RTM3205's 1 PPS on-time reference by the specified number of nanoseconds. Negative values add delay by retarding the 1 PPS and are used in special circumstances. The calibration value is determined by summing all the delays.

The calibration range is  $\pm 500,000$  nanoseconds. The default value as shipped from the factory is 0.

The table below lists nominal propagation delays for the GPS cable and accessories supplied by EndRun Technologies. For the most demanding timing applications, it is recommended that the delay between the antenna and RTM3205 receiver input be precisely measured.

EndRun Part #	Description	Nominal Delay	Notes
	<b>Antenna Cable</b>		
0610-0009-001	Kit with 50' (15m) cable	62 nanoseconds	Belden 9104, 1.24 ns/foot
0600-0013-050	50' (15m) cable	62 nanoseconds	Belden 9104, 1.24 ns/foot
0600-0013-100	100' (30m) cable	124 nanoseconds	Belden 9104, 1.24 ns/foot
0600-0013-150	150' (46m) cable	186 nanoseconds	Belden 9104, 1.24 ns/foot
0600-0013-200	200' (61m) cable	248 nanoseconds	Belden 9104, 1.24 ns/foot
0600-0013-250	250' (76m) cable	310 nanoseconds	Belden 9104, 1.24 ns/foot
0600-0060-800	800' (244m) cable	992 nanoseconds	Belden 1505A, 1.24 ns/foot
0600-0060-A00	1000' (304m) cable	1240 nanoseconds	Belden 1505A, 1.24 ns/foot
	<b>GPS Low-Noise Amplifier</b>		
3509-0001-000	G-LNA2	20 nanoseconds	See device label for exact delay.
4011-0002-000	G-LNA2 Kit (with 1' cable)	21 nanoseconds	See device label for exact delay and add 1.24 ns for the 1' cable.
0502-0009-000	<b>Lightning Arrestor</b>	<1 nanosecond	
0502-0011-000	<b>GPS Signal Splitter</b>	<1 nanosecond	
	<b>Fiber Optic Link</b>		
3430-0003-000	Fiber Optic Receiver	17 nanoseconds	Add the delay of single mode fiber optic cable which is typically 1.4/1.5 ns/foot. See cable specification.
3430-0004-000	Fiber Optic Transmitter	per	
3430-0005-000	Fiber Optic Transmitter	Receiver/Transmitter pair.	

## Mounting On A Rooftop

Mounting your GPS antenna with an unobstructed view of the sky (usually on a rooftop) is the recommended installation. Please follow these guidelines to eliminate exposure to electrical service wiring and to minimize the potential for lightning strikes.



Installations subject to lightning strikes should use a lightning arrestor installed at the building entrance. A lightning arrestor suited for this purpose is available through EndRun Technologies. The arrestor must be installed according to the manufacturer's instructions.



Do NOT route the antenna wiring near or with AC wiring (Class 1 circuits per the NEC). Do NOT mount the antenna wiring where it may become energized by nearby AC wiring or components should they fall.

## Obtaining A Reference Position

Your RTM3205 is capable of operation from either an automatically determined GPS reference position or a manually entered GPS reference position. If you need to provide a reference position to your RTM3205, it is best to use a previously determined position from the unit itself or a highly accurate surveyed position.

## About WGS-84 Height

Internally, GPS receivers report latitude, longitude and height above the WGS-84 ellipsoid. However, for a lot of reasons, WGS-84 is not the way that mapmakers and surveyors report the height. That means, in order to use the height information as reported by RTM3205, you need to do a conversion. One easy way to do the conversion is by going to this link:

[unavco.org/software/geodetic-utilities/geoid-height-calculator/geoid-height-calculator.html](http://unavco.org/software/geodetic-utilities/geoid-height-calculator/geoid-height-calculator.html)

After entering your latitude and longitude, this website will give you a report showing the GPS ellipsoidal height, the Geoid height, and the Orthometric height. The Orthometric height is the one most people are familiar with, which is height above mean sea level. However, GPS receivers use the GPS ellipsoidal height. Below is a sample report:

GPS ellipsoidal height = 0 (meters)

Geoid height = -31.023 (meters)

Orthometric height (height above mean sea level) = 31.023 (meters)

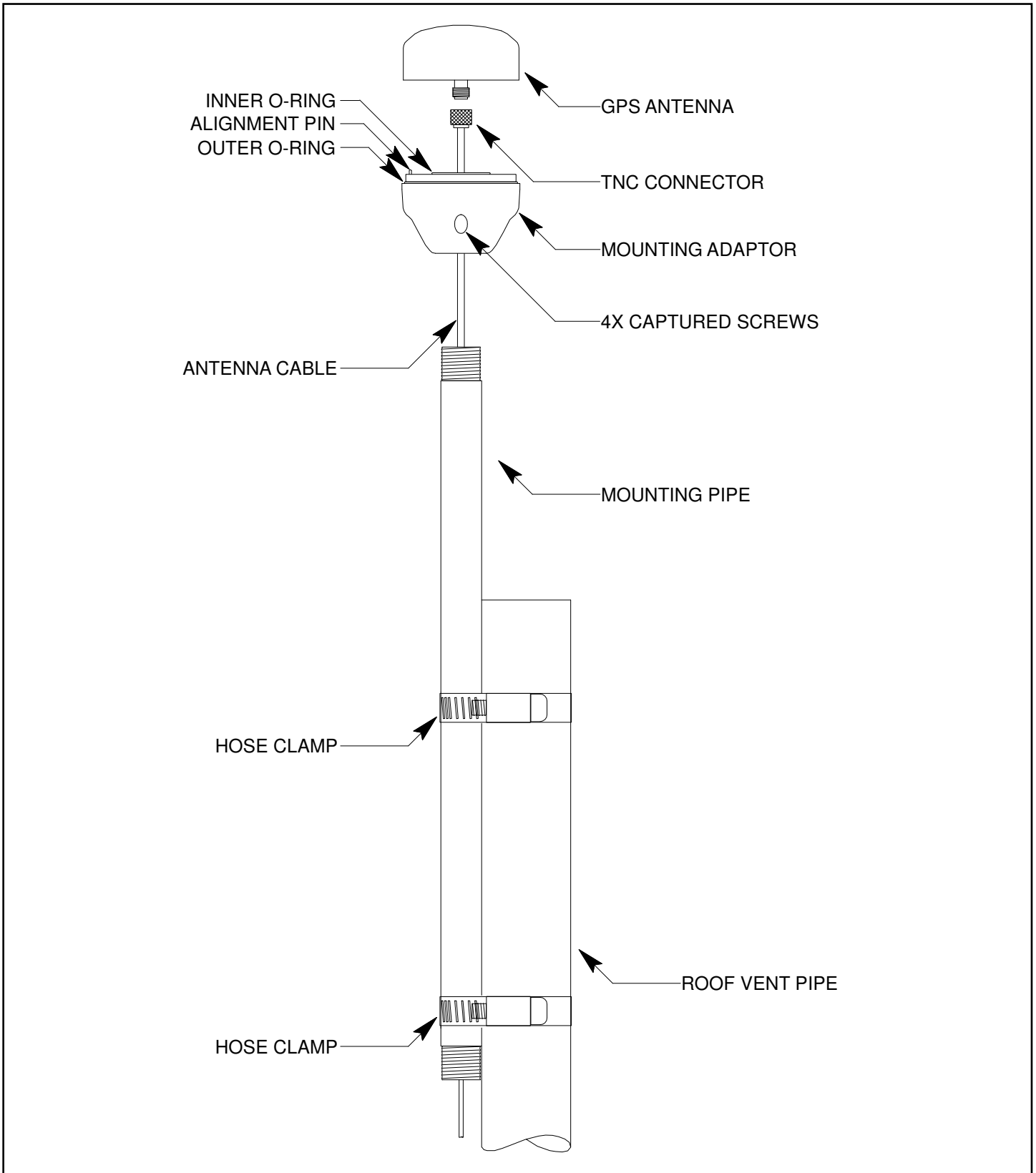

FIGURE 1 - GPS ANTENNA ROOFTOP MOUNTING HARDWARE



## INSTALLING THE GPS ANTENNA

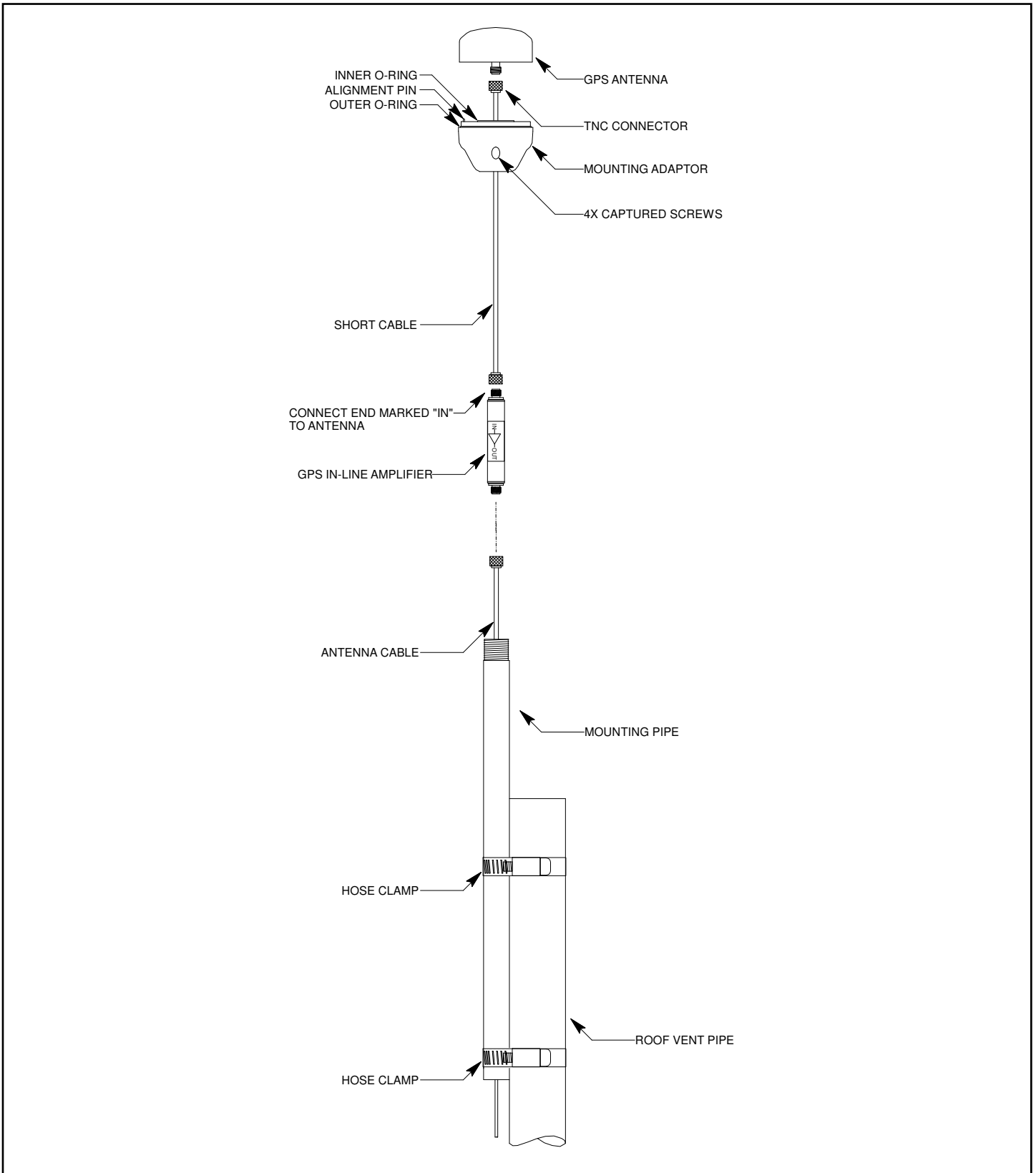

FIGURE 2 - GPS ANTENNA ROOFTOP MOUNTING HARDWARE WITH PREAMPLIFIER

---

## APPENDIX E

This page intentionally left blank.

# Appendix F

## Leap Seconds

*UTC stands for Coordinated Universal Time. UTC is the international time standard most commonly used in the world and by the Network Time Protocol (NTP). A leap second insertion is scheduled about every one-and-a-half to three years in order to keep UTC in alignment with the Earth's rotation. Possible leap second insertions can be scheduled at 23:59:59 UTC on June 30 or December 31.*

### Automatic Leap Second Insertion

Your GPS-synchronized RTM3205 precisely adjusts for leap seconds if and when they occur. There is nothing you need to do in order to keep your RTM3205 accurately synchronized to UTC.

You can see the current GPS-UTC parameters that are downloaded from the satellites by using the `gpsutcinfo` command. See *Chapter 3 - Console Port Control and Status* for details on this command or type `help gpsutcinfo` at the console port.

### Background Information

Leap seconds are inserted from time-to-time in order to keep UTC, which is derived from atomic time (TAI), in agreement with the Earth's rotation rate. Relative to TAI, the Earth's rotation rate is slowing down. This means that UTC must be retarded periodically in order to maintain agreement between UTC and the apparent daylength. If this were not done, eventually UTC would drift out-of-sync with Earth's day and many astronomical and navigational problems would ensue.

The International Earth Rotation and Reference Systems Service (IERS) is the organization responsible for measuring the relationship between UTC and the rotation rate of the Earth. When the difference between UTC and apparent Earth time has exceeded a certain threshold, the IERS coordinates with the Bureau International of the Hour (BIH) to schedule the insertion of a leap second into the UTC time scale. The IERS publishes *Bulletin C* about 6 months in advance of each possible leap second insertion point. *Bulletin C* confirms whether a leap second will or will not be inserted at the next possible insertion point. The IERS website is:

<http://www.iers.org>

EndRun summarizes this information at this link:

<http://www.endruntechnologies.com/leap.htm>

---

## APPENDIX F

This page intentionally left blank.

# Appendix G

## System Faults

The status of the RTM3205 is constantly monitored and a fault will occur when any of several parameters is out of spec. When this happens the Alarm LED on the front panel will light. This appendix defines the various faults.

### Overview

The Alarm LED will light when a fault has occurred. You can see which fault is the problem by using the `faultstat` command.

### Masking Faults

Some faults can be masked. These are the ANT (GPS Antenna) and SIG (GPS Signal) faults. When masked, these faults will not cause an alarm. You may want to mask the ANT fault if you are using a GPS splitter. You may want to mask the SIG fault if you are operating your RTM3205 as a Stratum 2 NTP Server and are not using a GPS signal. For information on Stratum 2 see *Chapter 7 - NTP, Configuring the RTM3205 as a Stratum 2 Server*.

To mask a fault you can use console port commands `setantfltmask` and `setsigfltmask`. For more information see *Chapter 3 - Console Port Control and Status* or type `help setsigfltmask` and `help setantfltmask` on the console.

## System Fault Definitions

### System Oscillator DAC (DAC)

This fault indicates that the electronic frequency control DAC for the oscillator has reached either the high or low alarm limit while locked to the GPS signal. Unless the unit is being subjected to out-of-specification environmental conditions, this would indicate that the oscillator frequency has drifted near to the end of life region. This should normally only occur after at least ten years of operation. The unit will continue to function until the oscillator frequency finally reaches one of the actual DAC endpoints. The unit should be returned to the factory for oscillator replacement at your convenience.

### GPS Signal (SIG)

This fault indicates that the unit has not been able to acquire a GPS signal for one hour while the Time Figure of Merit has been 9, the unsynchronized condition. This could be due to a variety of reasons. If there are no other faults that could explain the inability to receive a signal, then there could be an antenna failure or blockage. If the condition persists indefinitely, and a problem with the antenna is not evident, then please contact EndRun Customer Support.

### GPS Subsystem FPGA Configuration (FPGA)

This fault indicates that the GPS Subsystem is unable to configure the FPGA. This is a fatal fault. Please contact EndRun Customer Support.

**GPS Subsystem FLASH Writes (FLSH)**

This fault indicates that the GPS Subsystem is unable to verify a write to the FLASH non-volatile parameter storage area. This should never occur under normal operation.. Please contact EndRun Customer Support.

**GPS Receiver Communication (RCVC)**

This fault indicates that the GPS Subsystem is unable to establish communications with the GPS Receiver. Please contact EndRun Customer Support.

**GPS Reference Time (REF)**

This fault indicates that the GPS Subsystem received an erroneous time input from the GPS Receiver. If the condition persists please contact EndRun Customer Support.

**Subsystem Communication (POLL)**

This fault indicates that the GPS Subsystem is not receiving polling requests from the Linux Subsystem. This could be due to a hardware or software failure. If the condition persists please contact EndRun Customer Support.

**GPS Receiver (RCVF)**

This fault indicates a problem with the GPS Receiver. See the section below (*Receiver Faults*) for more information.

**System Oscillator PLL (Phase-Lock-Loop)**

This fault indicates that there is an unlock condition between the main system oscillator and the other system timebase clocks. This is a fatal fault. Please contact EndRun Customer Support.

**GPS Antenna (ANT)**

This fault indicates that the GPS antenna or cable has a fault. It indicates either an over or under current condition. Usually it means that the antenna cable is not plugged into the connector on the RTM3205. To see whether it is a short or an open check the receiver faults. This fault may also occur when using an antenna signal splitter. In this case you may want to mask the fault. Use the `setantfiltmask` command.

## Receiver Fault Definitions

When a fault on the GPS Receiver occurs, the system fault indicator RCVF will show fault and the Alarm LED will light. You can see which fault is the problem by using the `faultstat` command. Below are details about each fault indicator.

**GPS Receiver Oscillator DAC (DAC)**

This fault indicates that the DAC for the oscillator has reached either the high or low alarm limit while locked to the GPS signal. Unless the unit is being subjected to out-of-specification environmental conditions, this would indicate that the oscillator frequency has drifted near to the end of life region. This should normally only occur after at least ten years of operation. The unit will continue to function until the oscillator frequency finally reaches the DAC endpoint. The unit should be returned to the factory for oscillator replacement at your convenience.

---

## SYSTEM FAULTS

### **GPS Signal (SIG)**

This fault indicates that the GPS Receiver has not been able to acquire a GPS signal for one hour while the Time Figure of Merit has been 9, the unsynchronized condition. This could be due to a variety of reasons. If there are no other faults that could explain the inability to receive a signal, then there could be an antenna failure or blockage. If the condition persists indefinitely, and a problem with the antenna is not evident, then please contact EndRun Customer Support.

### **GPS Receiver FPGA Configuration (FPGA)**

This fault indicates that the GPS Receiver is unable to configure the FPGA. This is a fatal fault. Please contact EndRun Customer Support.

### **GPS Receiver FLASH Writes (FLSH)**

This fault indicates that the GPS Receiver is unable to verify a write to the FLASH non-volatile parameter storage area. This should not ever occur under normal operation.. Please contact EndRun Customer Support.

### **Synthesizer Limits (SYN1)**

This fault indicates that the local oscillator synthesizer has reached the alarm limit. This condition should not normally occur unless the unit is subjected to out-of-specification environmental conditions. Otherwise, this is a fatal fault. Please contact EndRun Customer Support.

### **Synthesizer (SYN2)**

This fault indicates that the local oscillator synthesizer has failed. This condition should not normally occur unless the unit is subjected to out-of-specification environmental conditions. Otherwise, this is a fatal fault. Please contact EndRun Customer Support.

### **GPS Reference Time (REF)**

This fault indicates that the GPS Receiver received an erroneous time input from the GPS signals. If the condition persists please contact EndRun Customer Support.

### **GPS Receiver Oscillator (OSC)**

This fault indicates that the main oscillator has failed. This is a fatal fault. Please contact EndRun Customer Support.

### **Antenna Short (SHRT)**

This fault indicates that the GPS antenna has an overcurrent condition (short).

### **Antenna Open (OPEN)**

This fault indicates that the GPS antenna has an undercurrent condition (open).

### **GPS Receiver Oscillator PLL (Phase-Lock-Loop)**

This fault indicates that there is an unlock condition between the receiver oscillator and the other system timebase clocks. This is a fatal fault. Please contact EndRun Customer Support.

---

## APPENDIX G

This page intentionally left blank.



# Appendix H

## *Time Code Formats*

*An optional feature of your RTM3205 Precision Timing Module is one amplitude-modulated time code output, or up to four DC-shift time code outputs. Time codes are commonly used to provide time information to external devices such as displays, magnetic tape devices, strip chart recorders and several types of embedded computer peripheral cards. The output code format is selectable via a console command. See **Chapter 10 - Inputs/Outputs, Time Code Option**. Each format is described below.*

### **IRIG-B122/002**

This is the most widely used format and is normally the factory default. The IRIG-B122 format is a 100 bps code and is used to amplitude modulate a 1000 kHz sine wave carrier. The information contained in the time code is seconds through day-of-year coded in Binary Coded Decimal (BCD). Reference IRIG Document 104-60.

### **IRIG-B123/003**

In addition to the time information identified in B122 above, this format also contains Straight Binary Seconds (SBS) of day. SBS is provided at the end of the frame, in the 17 bits starting in position 80.

### **IRIG-B120/000 (IEEE-Standard 1344-1995)**

In addition to the time data and the Straight Binary Seconds data this format provides for time/status data in the control bit positions of IRIG-B. The information provided there is defined by IEEE standard 1344-1995: Unit and Tens of Years, Leap Second, DaylightSaving Time, Local Time Offset, Time Quality and Parity. The IEEE-1344 table provided below shows each bit position with detailed information.

### **NASA-36**

NASA-36 bit time code is a 100-bit, pulse width modulated format used to amplitude modulate a 1000 kHz sine wave carrier. The information contained in the time code is seconds, minutes, hours and days. The format is used by several military ranges. Reference IRIG Document 104-59.

### **2137**

The 2137 code is a 25-bit pulse width modulated format used to amplitude modulate a 1000 kHz sine wave carrier. The information contained in the time code is seconds, minutes and hours. The format is used by certain security organizations.

## IEEE-1344 Bit Definition

Bit Position	Bit Definition	Explanation
P50	Year, BCD1	Unit years
P51	Year, BCD2	
P52	Year, BCD4	
P53	Year, BCD8	
P54	Not used	
P55	Year, BCD10	Tens years
P56	Year, BCD20	
P57	Year, BCD40	
P58	Year, BCD80	
P59	P6	Position identifier
P60	Leap second pending	Set to one, 59 seconds prior to leap insertion
P61	Leap second	0 = add second, 1 = delete second
P62	DaylightSaving Time pending	Set to one, 1 second prior to DST change
P63	DaylightSaving Time	1 = DST active
P64	Local offset sign	0 = +, 1 = -
P65	Local offset binary 1	Local offset from UTC time
P66	Local offset binary 2	
P67	Local offset binary 4	
P68	Local offset binary 8	
P69	P7	Position identifier
P70	Local offset half hour bit	0 = none, 1 = half hour time offset added
P71	Time quality binary 1	Time quality indicates clock precision.*
P72	Time quality binary 2	
P73	Time quality binary 4	
P74	Time quality binary 8	
P75	Parity	Odd parity for all preceding data bits
P76-P78	Not used	
P79	P8	Position identifier

- \* 0 normal operation, clock locked (TFOM = 3)  
 4 time error is < 1 us  
 5 time error is < 10 us  
 6 time error is < 100 us  
 7 time error is < 1 ms  
 8 time error is < 10 ms  
 9 time error is > 10 ms  
 F time not reliable, never locked to GPS

Refer to *Appendix A - Time Figure-of-Merit* for detailed information on TFOM and time error.

# Appendix I

## Software Options

Your RTM3205 supports software options. Software options are the RTIC Option described in **Chapter 11 - Real-Time Ionospheric Correction (RTIC)**, the Precision Time Protocol described in **Chapter 9 - PTP/IEEE-1588** and Synchronous Ethernet described in **Chapter 12 - SyncE**. This appendix is about viewing or enabling software options, using the PTP Option in the examples below.

Normally, EndRun products are configured from the factory with software options enabled. But software options are also field-installable. In other words, you can enable a software option yourself, after you have received your RTM3205. First you must obtain an 8-digit license key from EndRun Technologies, then you can enable it using the `wrt_sw_opt` command.

### `wrt_sw_opt`

To enable a software option use this console port command. You must be logged in as the root user in order to run this command and you must provide a license key on the command line. If the key is verified, then the option will be enabled.

```
Command:      wrt_sw_opt [key]
RTM3205 reply: Option to be enabled is PTP0 Daemon
```

### `get_sw_opts`

This command shows which software options are enabled in your RTM3205. The command returns a 32-bit value with each bit identifying a software option. See *Software Option Bit Definitions* below. Here is an example when no software options are enabled:

```
Command:      get_sw_opts
RTM3205 reply: 00000000000000000000000000000000
```

Bits are numbered from 0 to 31, from right to left. This example shows bit 0 set which identifies that the PTP0 option is enabled.

```
Command:      get_sw_opts
RTM3205 reply: 00000000000000000000000000000001
```

### `installed_sw_opts`

This is another command that shows which software options are enabled. Below is an example:

```
Command:      installed_sw_opts
RTM3205 reply: The PTP0 Daemon is Installed.
               The Real-Time Iono Corrections Option is Installed.
```

**Software Option Bit Definitions**

Bits are numbered from 0 to 31, from right to left. Currently, there are only four software options defined in the RTM3205. These are for the SyncE Option, the RTIC Option and PTP/IEEE-1588 enabled on port 0 (eth0) or port 1 (eth1). The table below shows the currently defined bits.

Bit 31	Bit 30	.....	Bit 6	Bit 5	Bit 4	Bit 3	Bit 2	Bit 1	Bit 0
						SyncE	RTIC	PTP Port 1 (eth1)	PTP Port 0 (eth0)

# Appendix J

## *Operation with a GPS Simulator*

*This appendix describes several commands that are intended for use before and after operation with a GPS simulator. In addition, recommendations for the simulator setup are given so that the advanced integrity-checking and GPS week number ambiguity resolution algorithms operating in the GPS Subsystem will not cause unexpected behaviors during and after running on the simulator.*

### Background

GPS-based timing systems supporting critical infrastructure functions could be vulnerable to malfunction due to weak signals, jamming, spoofing or accidental GPS control system errors. EndRun Technologies' GPS timing receiver technology has evolved to be highly robust against these threats. Because of this, operation with a GPS simulator requires careful attention when setting up the simulator. Careful consideration must also be given in configuring the GPS Subsystem before and after simulator operation. Failure to understand and implement the information that follows could result in confusing simulation results and/or improper operation when the RTM3205 is subsequently reconnected to live GPS signals.

### Console Port Commands

#### **clearalmanac**

The GPS Subsystem maintains a record of the GPS almanac data received from the satellites in its non-volatile memory. These almanacs are used to calculate the elevations and doppler frequency offsets of GPS satellites so that they may be more quickly acquired and tracked by the signal processor. When operating on a GPS simulator, any previously stored almanacs gathered from the live GPS may not contain valid data, so they should be cleared prior to operation with a simulator. Likewise, following operation with a simulator, they should also be cleared before reconnecting to live GPS signals. The **clearalmanac** command provides this capability.

This command clears all GPS almanac data from both non-volatile and working memory in the GPS Subsystem. (It does not clear the copy of the Yuma-formatted almanac that is retrieved with the **dumpalmanac** command. That data will be updated on reception of new almanac data.)

The **clearalmanac** command can be used at other times, but is typically used before and after operation with a GPS simulator.

#### SUMMARY

The **clearalmanac** command **MUST** be executed both before and after use with a GPS simulator.

Command: **clearalmanac**  
RTM3205 reply: **Clearing GPS Almanacs**

### **resetlastgpswn**

The GPS Subsystem is designed to autonomously handle future rollovers of the 10-bit GPS week number received in data from the satellites. To do that, it maintains a record in non-volatile memory of the unambiguous, full GPS week number when it was last locked to the GPS system, i.e. the Last GPS Week Number. If this information is not available, then the full GPS week number corresponding to the build date of the GPS receiver firmware will be used as the Last GPS Week Number.

This Last GPS Week Number is the minimum possible full GPS week number. The RTM3205 will never allow the date and time to be set prior to the date and time corresponding to this Last GPS Week Number. For example, setting the simulator time to a date two weeks in the past will result in the RTM3205 setting the date 1022 weeks in the future.

*This means that a simulator should not be set to a date in the past.* Doing so will cause the time to be set a multiple of 1024 weeks in the future relative to the simulator time. If lock to the simulator is then achieved, this future time will then be saved to non-volatile memory as the Last GPS Week Number. Subsequent runs with the simulation time set in the past would cause this time to continue to advance.

Following simulator operation, it is imperative that the non-volatile Last GPS Week Number be reset to the firmware build date. This is accomplished by running the **resetlastgpswn** command prior to reconnecting to live GPS signals.

### **SUMMARY**

The simulator should not be set to a date in the past.

You **MUST** disconnect the antenna or simulator from the RTM3205 and then execute the **resetlastgpswn** command before reconnecting the RTM3205 to a live GPS signal.

### **IMPORTANT**

This command should not be used unless you have reason to believe that operation with a GPS simulator has previously taken place. Arbitrary usage of this command could compromise the effectiveness of the algorithm in autonomously handling the GPS week number rollover events.

The command must be issued with one argument: **TRUE**

Command: **resetlastgpswn TRUE**  
RTM3205 reply: **Resetting Last GPS Week Number**

**resetleaphistory**

The GPS Subsystem performs extensive integrity/sanity checking on the data received from the GPS satellites. In particular, the current and future UTC leap second values received in the almanac data are compared to a historical record of previous UTC leap seconds and the GPS week numbers at which they were inserted into the UTC timescale. Should a simulator be set with arbitrary values for these UTC leap seconds that differ by more than a couple of seconds from the actual values currently being transmitted by the GPS, the almanac data will be rejected.

*The simulator should be set with realistic UTC leap second values.* If the simulator is set with incorrect UTC leap second values, yet they are close enough to pass the integrity screen, then they will be accepted and it will be necessary to run the **resetleaphistory** command prior to reconnecting to live GPS signals. Failure to do so would compromise the integrity checking algorithm.

Issuing this command will reset the stored GPS Leap Second History to the history that was correct at the build date of the receiver firmware. As long as the firmware build date is not too many years old, this will allow the receiver to operate properly when it receives signals from the actual GPS satellites.

**SUMMARY**

The simulator should be set with realistic UTC leap second values, such as those currently being transmitted by GPS. If you simulate a leap second insertion then you **MUST** execute the **resetleaphistory** command before reconnecting the receiver to a live GPS signal.

**IMPORTANT**

This command should not be used unless you have reason to believe that operation with a GPS simulator has previously taken place. Arbitrary usage of this command could cause important leap history events to be lost. This will compromise the effectiveness of the integrity checking algorithm.

The command must be issued with one argument: TRUE

Command:       **resetleaphistory TRUE**  
RTM3205 reply: **Resetting Leap History**

---

## APPENDIX J

This page intentionally left blank.



# Appendix K

## Specifications

*The following accuracy and stability specifications assume a stationary position (not dynamic mode), four satellite lock, and the antenna mounted with a full view-of-the-sky.*

### GPS Receiver:

L1 Band – 1575.42 MHz.  
 12 Channels, C/A Code (16 correlators).  
 Static mode and dynamic-platform mode (shipboard only).  
 15 dB minimum gain at receiver input.  
 Timing Receiver Autonomous Integrity Monitoring (TRAIM).  
 TNC connector (female) on rear panel,  $Z_{in} = 50\Omega$ , 5 VDC to antenna.

### GPS Antenna Kit (Option):

#### Antenna

TNC jack on rear panel,  $Z_{in} = 50\Omega$ , antenna power = +5V.  
 Integral +40 dB gain LNA with bandpass filter for out-of-band interference rejection.  
 Rugged, all-weather housing capable of operation over  $-40^{\circ}\text{C}$  to  $+85^{\circ}\text{C}$ .  
 MTBF: 163,441 hours at  $70^{\circ}\text{C}$ .  
 Size: 3.25”H x 3.0” diameter.  
 Mounting via 18” long,  $\frac{3}{4}$ ” pipe with stainless steel clamps.  
 50’ low-loss RG-59 downlead cable standard.  
 Extension cables and low noise pre-amplifiers are available.

### Time to Lock:

< 10 minutes, typical (OCXO).

### Timing Characteristics:

*Accuracy:* < 10 nanoseconds RMS to UTC(USNO) when locked.\*

*Stability:* TDEV < 10 ns,  $\tau < 10^5$  seconds,  $\sigma_y(\tau) < 6.0 \times 10^{-14}$  @  $\tau=10^5$  secs.

*Stability:* TDEV < 2 ns,  $\tau < 10^5$  seconds,  $\sigma_y(\tau) < 4.0 \times 10^{-14}$  @  $\tau=10^5$  secs with the RTIC Option.

See **Chapter 11 - Real-Time Ionospheric Corrections, Specifications.**

*User-Calibration:* +/- 500 us, 1 ns resolution.

\*See [GPS-UTC Timing Specifications](#) for details.

### Platform:

*Operating System Kernel Version:* 3.2.2

*Slackware Linux Distribution:* 14.2

*Processor:* 1.2 GHz.

*RAM:* 512M

*FLASH:* 512M

**System Status LEDs:**

*Sync LED:* Amber LED pulses to indicate GPS acquisition and lock status.

*Alarm LED:* Red LED indicates a fault condition.

**Network I/O:**

Two front-panel RJ-45 jacks.

10/100/1000Base-T Ethernet.

Two LEDs on each port indicate speed and activity.

Amber LED indicates activity.

Green LED indicates speed (1 pulse = 10M, 2 pulses = 100M, 3 pulses = 1G).

**NTP Server Performance and Synchronization Accuracy:**

*NTP Timestamp Accuracy:* <10 microseconds @ 7500 requests/second.

**Supported IPv4 Protocols:**

SNTP, NTP v2, v3, v4, SHA/MD5 authentication, broadcast/multicast and autokey

SSH client and server with “secure copy” utility, SCP

SNMP v1, v2c, v3 with Enterprise MIB

TIME and DAYTIME server

TELNET client/server

FTP client

DHCP client

SYSLOG

HTTPS

PTP/IEEE-1588 (See the *Software Options* section in this Appendix K.)

SynE (See the *Software Options* section in this Appendix K.)

**Supported IPv6 Protocols:**

SNTP, NTP v2, v3, v4, SHA/MD5 authentication, broadcast/multicast and autokey

SSH client and server with “secure copy” utility, SCP

SNMP v1, v2c, v3 with Enterprise MIB

TIME and DAYTIME server

HTTPS

Note: See *Chapter 8 - IPv6 Information* for more details.

**Serial Port I/O:**

*Signal:* I/O port at RS-232 levels for secure, local terminal access.

*Parameters:* 19200 baud, 8 data bits, no parity, 1 stop bit.

*Connector:* Front-panel DB-9M connector labeled “RS-232”.

To connect to a computer, a null-modem adapter must be used. The serial cable provided with the shipment is wired as a null-modem. Pinout for the RS-232 console port is shown below.

*Note:* For operational details see *Chapter 3 - Console Port Control and Status*.

## SPECIFICATIONS

RTM3205 DB9M Pin	Signal Name
1	Not Connected
2	Receive Data (RX)
3	Transmit Data (TX)
4	Not Connected
5	Ground
6	Not Connected
7	Not Connected
8	Not Connected
9	Not Connected

### Size:

Chassis: 1.7”H x 4.0”W x 10.0”D.  
Weight: < 3 lb. (1.35 kg.)  
Antenna: 3.25” H x 3” Diameter

### Environmental:

Operating Temperature: 0° to +50° C  
Storage Temperature: -40° to +85° C  
Antenna Operating Temperature: -40° to +85° C  
Operating Humidity: 5% to 90% RH, non-condensing.  
Storage Humidity: 5% to 95% RH, non-condensing.  
Maximum Operating Altitude: 13,125 ft. / 4000 meters

### Power:

15-28 VDC, 1A maximum.  
13W maximum.  
Connector: Molex Micro-Fit 3.0 2-pin jack.  
Mate: Molex 43025-0200 Housing.  
Molex 43030-0008 20-24 AWG terminal (2 required).

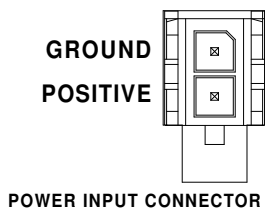

## Software Options

### Optional Real-Time Ionospheric Corrections (RTIC):

Specifications are listed in *Chapter 11 - RTIC* for more information.

### Optional PTP/IEEE-1588 Grandmaster:

IEEE-1588-2008 (v2) with hardware timestamping.

*Version 2 Parameters:* Default Profile. Multicast or Hybrid (mixed Unicast/Multicast), Two-Step Clock.

Delay Mechanism: E2E or P2P. Delay Interval: 32 seconds. Transport: UDP/IPv4.

Sync Interval: 1, 2, 4, 8, 16, 32, 64 or 128 packets / 1 second.

Announce Interval: 1 packet per 1, 2, 4, 8 or 16 seconds.

*PTP Timestamp Resolution:* 8 nanoseconds.

*PTP Timestamp Accuracy to Reference Clock:* 8 nanoseconds.

Note: See *Chapter 9 - PTP/IEEE-1588* for more information.

### Optional SyncE:

Synchronous Ethernet in RTM3205 meets the specifications defined in the ITU-T:

G.8261 Architecture and wander performance

G.8262 Timing characteristics

G.8264 Ethernet Synchronization Message Channel (ESMC)

Note: See *Chapter 12 - Synchronous Ethernet* for more information.

## System Oscillator

One of the following three OCXOs is used as the System Oscillator:

### Optional Medium-Stability OCXO (MS-OCXO):

*Temp Stability:*  $4 \times 10^{-9}$  over  $0^{\circ}$  to  $70^{\circ}$  C. *Ageing Rate/Year:*  $3 \times 10^{-8}$ .

*NTP Stratum 1 Holdover:* 35 days.

### Optional High-Stability OCXO (HS-OCXO):

*Temp Stability:*  $1 \times 10^{-9}$  over  $0^{\circ}$  to  $70^{\circ}$  C. *Ageing Rate/Year:*  $3 \times 10^{-8}$ .

*NTP Stratum 1 Holdover:* 35 days.

### Optional Ultra-Stable OCXO (US-OCXO):

*Temp Stability:*  $5 \times 10^{-10}$  over  $0^{\circ}$  to  $70^{\circ}$  C. *Ageing Rate/Year:*  $3 \times 10^{-8}$ .

*NTP Stratum 1 Holdover:* 35 days.

### System Oscillator Stability (Allan Deviation) Table (@ 10 MHz):

Tau in Seconds	MS-OCXO*	HS-OCXO*	US-OCXO*
1	$3.0 \times 10^{-12}$	$1.0 \times 10^{-12}$	$6.0 \times 10^{-13}$
10	$3.9 \times 10^{-12}$	$1.3 \times 10^{-12}$	$6.0 \times 10^{-13}$
100	$3.0 \times 10^{-12}$	$1.7 \times 10^{-12}$	$8.5 \times 10^{-13}$
1000	$2.0 \times 10^{-12}$	$1.5 \times 10^{-12}$	$8.0 \times 10^{-13}$
10000	$4.0 \times 10^{-13}$	$4.0 \times 10^{-13}$	$4.0 \times 10^{-13}$
100000	$6.0 \times 10^{-14}$	$6.0 \times 10^{-14}$	$6.0 \times 10^{-14}$

*System Oscillator Phase Noise on next page.*

---

## SPECIFICATIONS

### System Oscillator Phase Noise Table (dBc/Hz @ 10 MHz):

Hz	MS-OCXO	HS-OCXO	US-OCXO	Spurs
1	-95	-105	-110	
10	-120	-130	-135	-120
100	-135	-140	-148	-115
1k	-145	-150	-152	-125
10k	-145	-150	-153	-125
100k	-145	-150	-153	-110

### System Oscillator Phase Noise Table (dBc/Hz @ 5 MHz):

Hz	MS-OCXO	HS-OCXO	US-OCXO
1	-100	-110	-115
10	-130	-135	-140
100	-140	-145	-152
1k	-150	-155	-155
10k	-150	-155	-155
100k	-150	-155	-155

\*\*For RTIC Option see *Chapter 11 - Real-Time Ionospheric Corrections, Specifications*.

## Optional Outputs

### Optional 1 PPS Output:

*Signal:* Positive TTL pulse into 50Ω.

TTL (50Ω to GND):  $V_{OL(max)}=0.4V$ ,  $V_{OH(min)}=2.4V$ ,  $V_{OH(nom)}=2.5V$ ,  $V_{OH(max)}=3.0V$ .

*Width:* User selectable to 20 us, 1 ms, 100 ms, 500 ms.

*User-Calibration:* +/- 500 us, 1 ns resolution.

*Accuracy:* < 10 nanoseconds RMS to UTC(USNO) when locked.\*

*Stability:* TDEV < 10 ns @  $\tau < 10^5$  seconds,  $\sigma_y(\tau) < 6.0 \times 10^{-14}$  @  $\tau=10^5$  secs.

For RTIC Option see *Chapter 11 - Real-Time Ionospheric Corrections, Specifications*.

*Rise Time:* < 2 nanoseconds.

*Alignment:* Within 5 ns of the other TTL outputs in this unit (except the optional DDS).

*Connector:* Front-panel SMA jack labeled "1PPS".

*Note:* To change the pulse width refer to the *Chapter 10 - Inputs/Outputs, 1PPS Option*.

\*See [GPS-UTC Timing Specifications](#) for details.

### Optional AM Code Output:

*Signal:* Amplitude-modulated (AM), 3:1 ratio, 1 kHz carrier.

*Drive:* 1  $V_{RMS}$  into 50Ω.

*Format:* User selectable to IRIG-B (120/IEEE-1344/C37.118-2005, 122, 123), NASA-36, 2137.

*Alignment:* Within 5 us of 1 PPS.

*Connector:* Front-panel SMA jack labeled "AMCODE".

*Note:* To change the time code format refer to the *Chapter 10 - Inputs/Outputs, Time Code Output*.

**Optional DC Code Output :**

*Signal:* Positive TTL pulse into 50Ω (DC Level Shift).

TTL (50Ω to GND):  $V_{OL}(\max)=0.4V$ ,  $V_{OH}(\min)=2.4V$ ,  $V_{OH}(\text{nom})=2.5V$ ,  $V_{OH}(\max)=3.0V$ .

*Format:* User selectable to IRIG-B (000/IEEE-1344, 002, 003), NASA-36, 2137.

*Rise Time:* < 2 nanoseconds (TTL).

*Alignment:* Within 5 ns of the other TTL outputs in this unit (except the optional DDS).

*Connector:* Front-panel SMA jack labeled “DCCODE”.

*Note:* To change the format refer to **Chapter 10 - Inputs/Outputs, Time Code Output**.

**Optional Programmable Pulse Output (PPO):**

*Signal:* Positive TTL pulse into 50Ω.

TTL (50Ω to GND):  $V_{OL}(\max)=0.4V$ ,  $V_{OH}(\min)=2.4V$ ,  $V_{OH}(\text{nom})=2.5V$ ,  $V_{OH}(\max)=3.0V$ .

*Rate:* User selectable to 1, 10, 100, 1k, 10k, 100k, 1M, 5M, 10M PPS, 1PPM, 1PP2S.

*Accuracy:* <  $6 \times 10^{-14}$  to UTC for 100k second averaging times when locked.

*Stability:* TDEV < 10 ns @  $\tau < 10^5$  seconds,  $\sigma_y(\tau) < 6.0 \times 10^{-14}$  @  $\tau=10^5$  secs.

*Duty Cycle:* 50% except 1PPS which mimics the 1PPS Output defined above.

*Rise Time:* < 2 nanoseconds (TTL).

*Alignment:* Within 5 ns of the other TTL outputs in this unit (except DDS, if any).

*Connector:* Front-panel SMA jack labeled “PPO”.

*Note:* To change the selection refer to **Chapter 10 - Inputs/Outputs, Programmable Pulse Output**.

**Optional Direct Digital Synthesizer (DDS) Output:**

*Signal:* Positive TTL pulse into 50Ω.

TTL (50Ω to GND):  $V_{OL}(\max)=0.4V$ ,  $V_{OH}(\min)=2.4V$ ,  $V_{OH}(\text{nom})=2.5V$ ,  $V_{OH}(\max)=3.0V$ .

*Rate:* User selectable 1 PPS to 10MPPS in 1PPS steps (per system DDS setting).

*Accuracy:* <  $6 \times 10^{-14}$  to UTC for 100k second averaging times when locked.

*Rise Time:* < 2 nanoseconds (TTL).

*Alignment:* DDS rates are NOT aligned with the other pulse rates in this unit.

*Connector:* Front-panel SMA jack labeled “DDS”.

*Note:* To change the selection refer to **Chapter 10 - Inputs/Outputs, Direct Digital Synthesizer**.

**Optional 10 MPPS Rate Output:**

*Signal:* Positive TTL pulse into 50Ω.

TTL (50Ω to GND):  $V_{OL}(\max)=0.4V$ ,  $V_{OH}(\min)=2.4V$ ,  $V_{OH}(\text{nom})=2.5V$ ,  $V_{OH}(\max)=3.0V$ .

*Rate:* An on-time 10 MPPS pulse rate.

*Accuracy:* <  $6 \times 10^{-14}$  to UTC for 100k second averaging times when locked.

*Stability:* TDEV < 10 ns @  $\tau < 10^5$  seconds,  $\sigma_y(\tau) < 6.0 \times 10^{-14}$  @  $\tau=10^5$  secs.

*Rise Time:* < 2 nanoseconds (TTL).

*Alignment:* Within 5 ns of the other TTL outputs in this unit (except DDS, if any).

*Connector:* Front-panel SMA jack labeled “10MPPS”.

**Optional Alarm Output:**

*Signal:* MMBT2222A open collector, grounded emitter. High impedance in alarm state.

*Voltage:* 40 VDC, maximum.

*Saturation Current:* 100 mA, maximum.

*Connector:* Front-panel SMA jack labeled “ALARM”.

*Note:* See **Chapter 10 - Inputs/Outputs, Alarm Output** for more information.

---

## SPECIFICATIONS

### **Optional 10 MHz Low-Phase-Noise Output:**

*Output Level:* +13 dBm, +/- 2 dBm at 50Ω.

*Harmonics:* < -45 dBc at 50Ω.

*Channel-to-Channel Isolation:* > 60 dB

*Stability:* See **System Oscillator Stability (Allan Deviation) Table** above.

*Phase Noise:* See **System Oscillator Phase Noise Table** above.

*Alignment:* Not aligned with other outputs in this unit.

*Connector:* Front-panel SMA jack labeled "10M".

## **Compliance**

RoHS:                   RoHS Directive 2011/65/EC  
WEEE:                   WEEE Directive 2012/19/EC

*Data subject to change.  
EndRun Technologies may make changes to  
specifications and product descriptions  
at any time, without notice.*

APPENDIX K

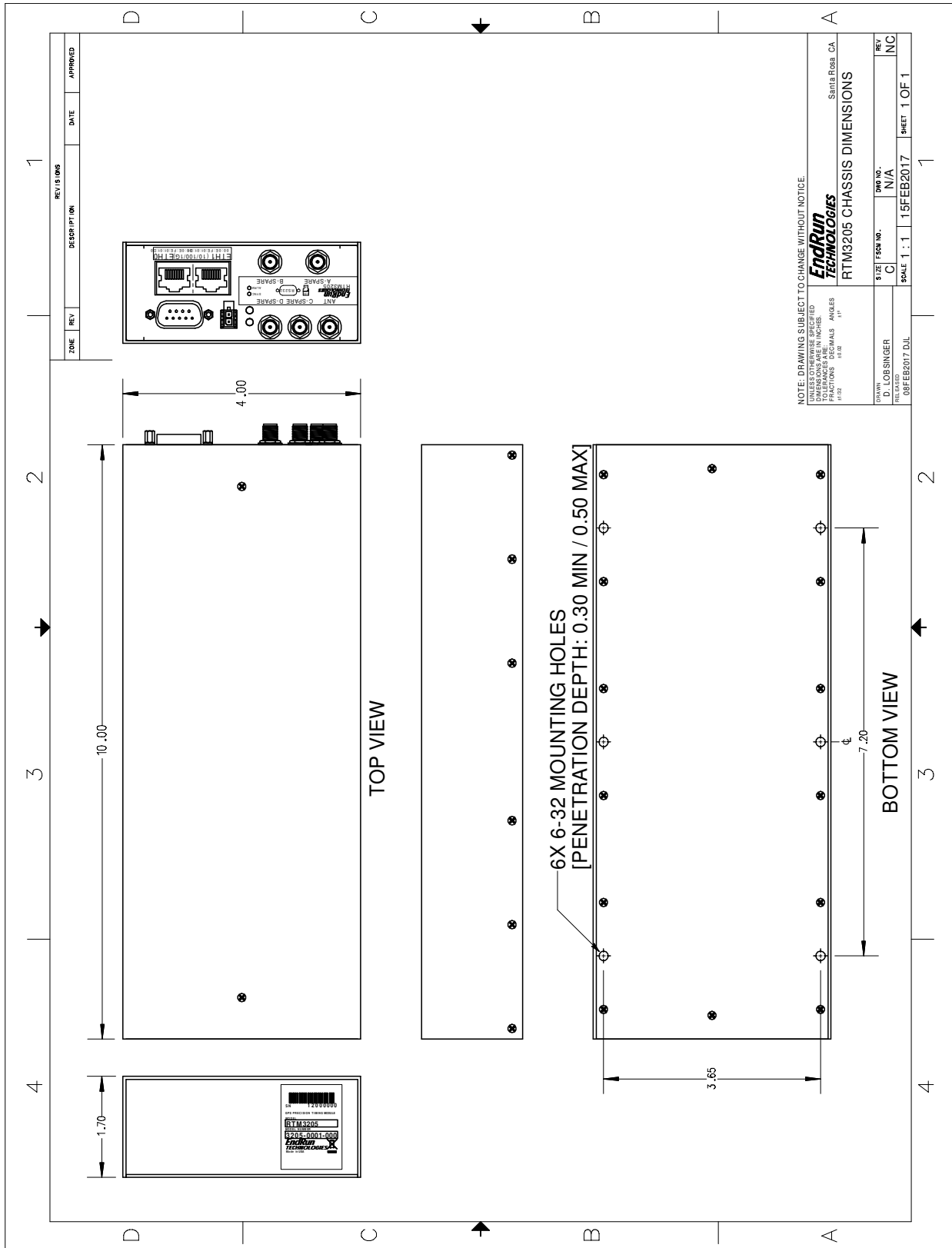

NOTE: DRAWING SUBJECT TO CHANGE WITHOUT NOTICE.  
 UNLESS OTHERWISE SPECIFIED  
 DIMENSIONS ARE IN INCHES.  
 FRACTIONS DECIMALS ANGLES  
 1/32 0.03125 15°

**EndRun Technologies**  
 RTM3205 CHASSIS DIMENSIONS  
 Santa Rosa, CA

DATE	08FEB2017	DRAWN BY	DOBINGER
REV	INC	CHKD BY	DOBINGER
SCALE	1 : 1	DATE	15FEB2017
SHEET	1 OF 1	REV	INC
SIZE	F504 W6	DWG NO.	N/A

RTM3205 DIMENSIONS



# Special Modifications

---

## *Changes for Customer Requirements*

From time to time EndRun Technologies will customize the standard RTM3205 Precision Timing Module for special customer requirements. If your unit has been modified then this section will describe what those changes are.

**This section is blank.**

---

## **SPECIAL MODIFICATIONS**

This page intentionally left blank.



**EndRun**  
**TECHNOLOGIES**

*"Smarter Timing Solutions"*

2270 Northpoint Parkway  
Santa Rosa, CA 95407  
TEL 1-877-749-3878  
FAX 707-573-8619  
[www.endruntechnologies.com](http://www.endruntechnologies.com)